

Seasonal forecasting at ECMWF

L. Ferranti

The operational forecasting system

High resolution forecast: twice per day TI 1279 ~ 16km 137-level, to 10 days ahead (next update Tco1279 ~ 9km)

Coupled atmosphere-ocean system

Ensemble Prediction System (ENS): twice daily TI 639/319 32/64 km 91-level, 51 members to 15 days ahead (next update Tco639 – 18Km)

Extended range forecasts /ENS extension: twice a week (Mon/Thu)

TI 639/319 ~ 32/64 km 91 levels, 51 members to 46 days ahead

(next update Tco639/319 18km/36Km)

**Long range forecasts: once a month - 51 members, ~80 km 91 levels,
to 7 months ahead**

Long range forecasts provide information about atmospheric and oceanic conditions averaged over the next few months.

Despite the chaotic nature of the atmosphere, long term predictions rely on a number of components which themselves show variations on long time scales (seasons and years) and, to a certain extent, are predictable.

The most important of these components is the **ENSO** (El Nino Southern Oscillation) cycle. Although ENSO is a coupled ocean-atmosphere phenomenon centred over the tropical Pacific it affect atmospheric circulation over remote regions.

- **ENSO variability**
- **Other tropical ocean SST**
- **Climate change** - long term trends
- **Land surface conditions** - e.g. soil moisture in 2003, sea-ice

THE EL NIÑO/SOUTHERN OSCILLATION (ENSO) CYCLE

December - February Normal Conditions

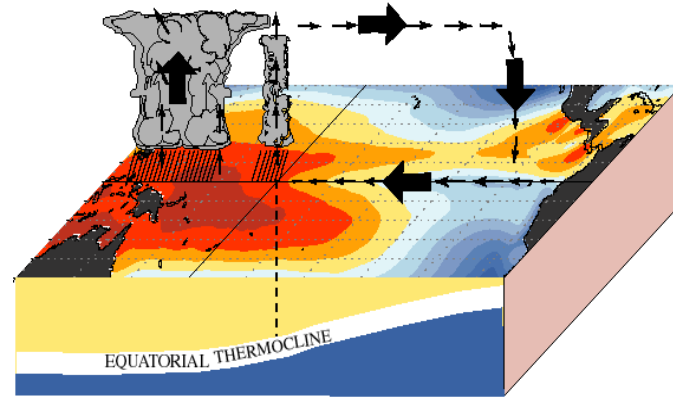

December - February El Niño Conditions

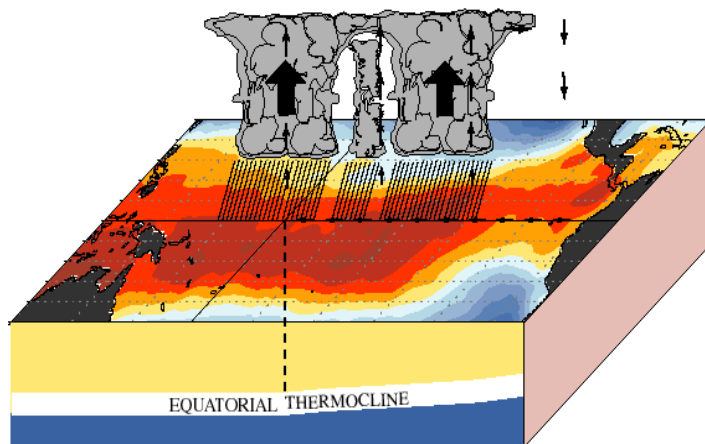

December - February La Niña Conditions

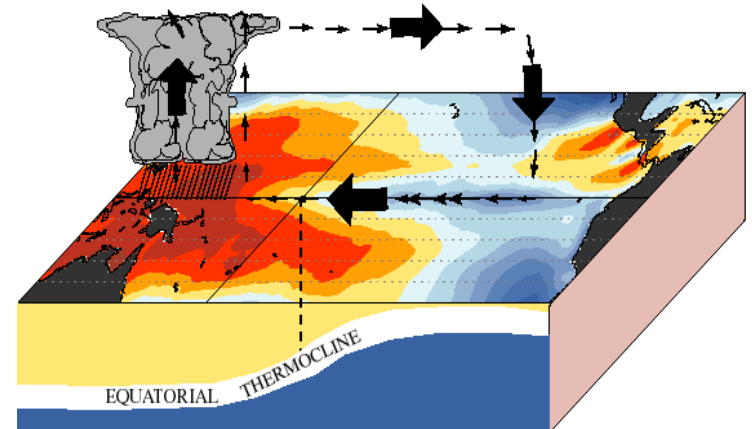

ENSO global impacts:

El Niño and Rainfall

El Niño conditions in the tropical Pacific are known to shift rainfall patterns in many different parts of the world. Although they vary somewhat from one El Niño to the next, the strongest shifts remain fairly consistent in the regions and seasons shown on the map below.

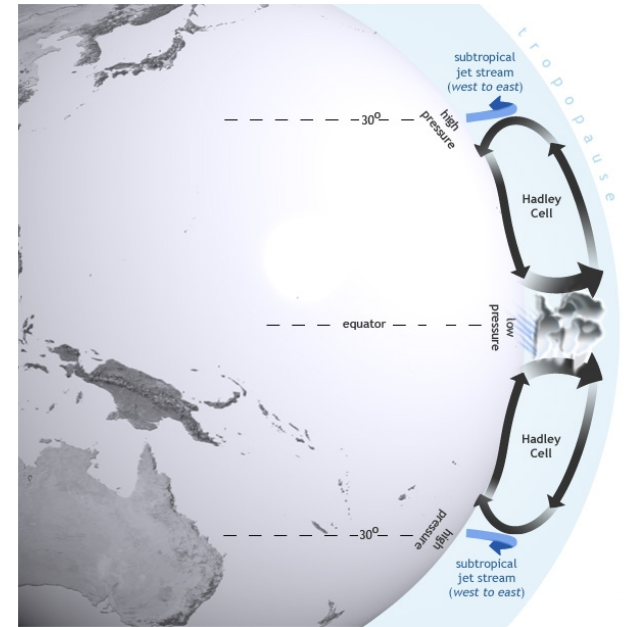
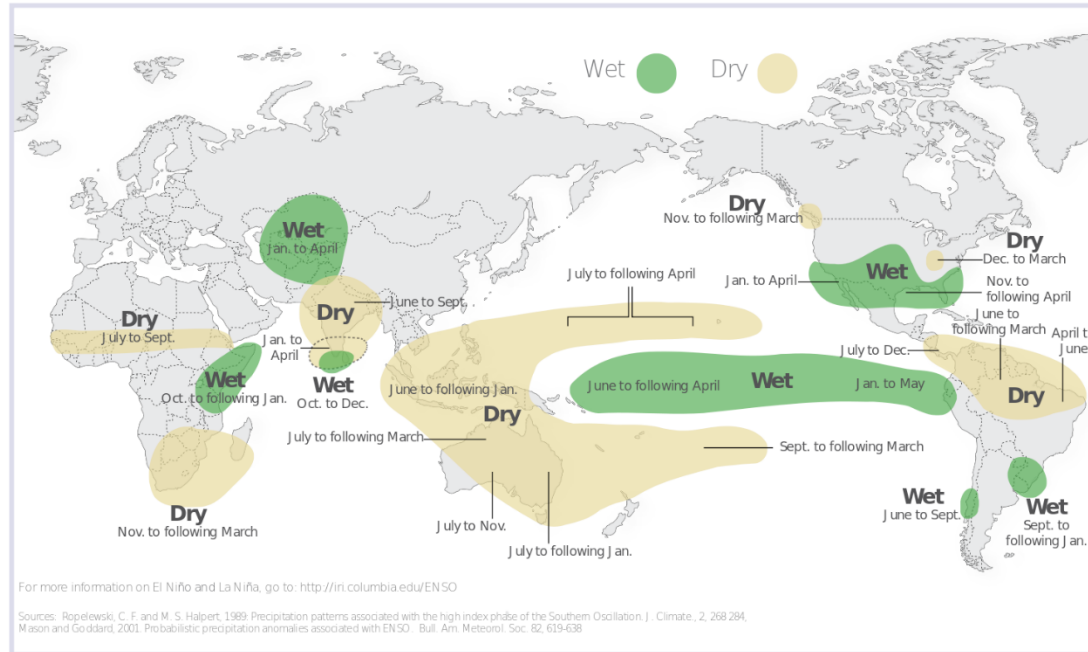

By strengthening the Hadley circulation, El Niño can trigger a cascade of noticeable departures from the normal rainfall patterns around the globe. The changes stretching across the globe are called El Niño teleconnections. Teleconnection patterns emerge in climate simulations, and they show up in historical observations.

ECMWF Seasonal Forecasting System

Observations

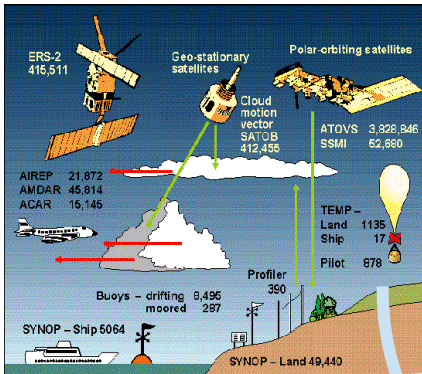

Data Assimilation

Current state of the atmosphere

Current state of the ocean

Coupled model

Atmospheric model



Coupler



Ocean Model

Forecast Products

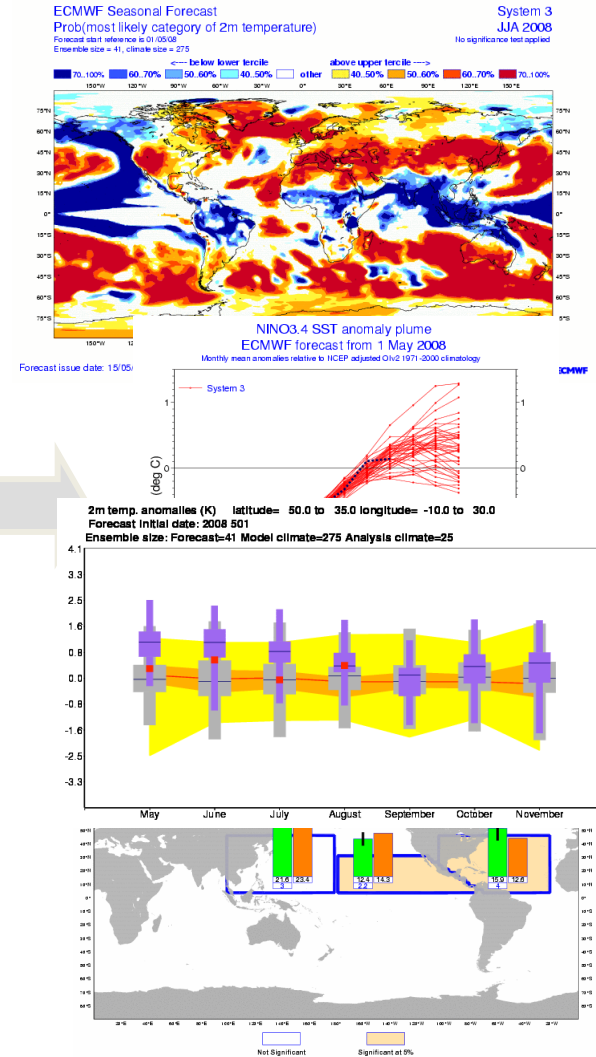

Initialization:

Data Assimilation

Observations

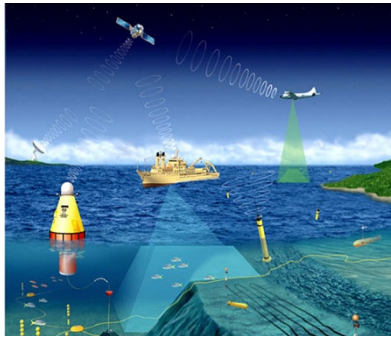
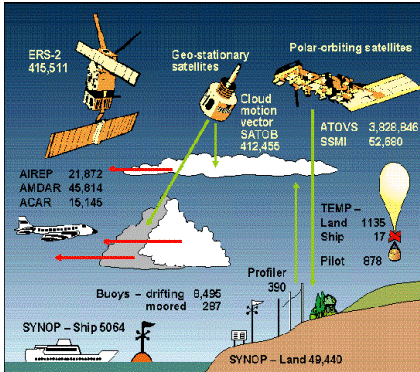

Current state
of the
atmosphere

Current state
of the
ocean

System 4

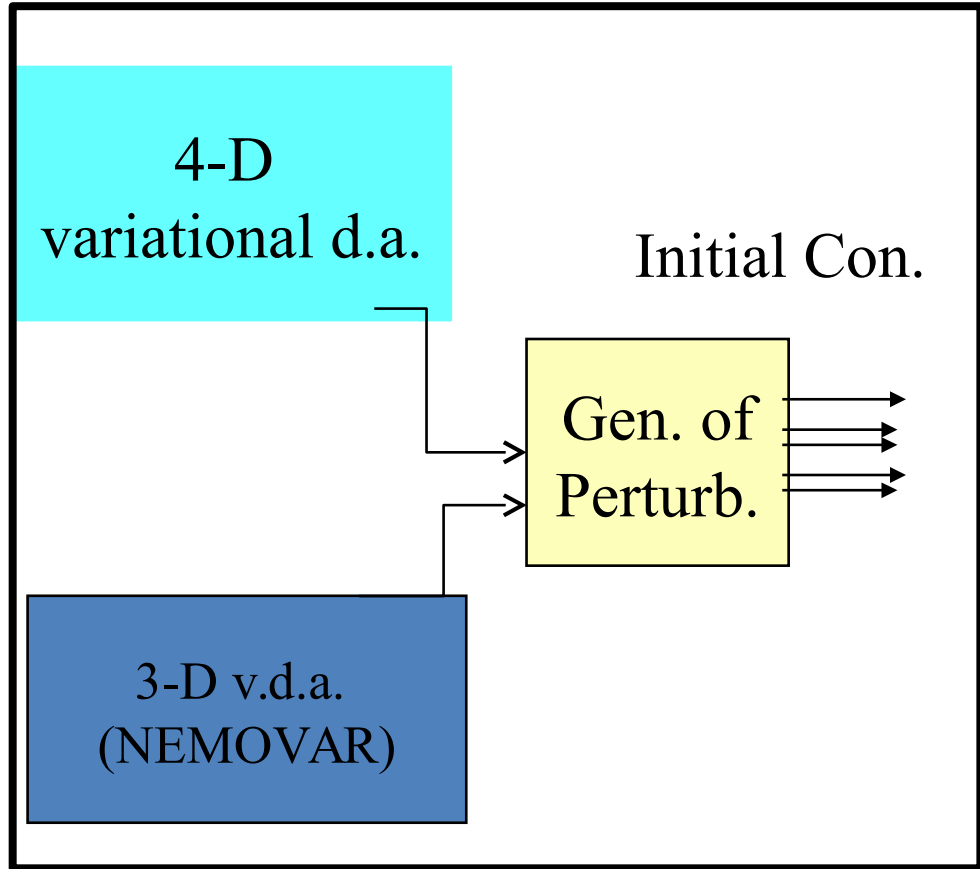

Ocean Observing System

Data coverage for June 1982



Changing observing system is a challenge for consistent reanalysis

Data coverage for Nov 2005



Today's Observations will be used in years to come

▲ Moorings: Subsurface Temperature

◇ ARGO floats: Subsurface Temperature and Salinity

+ XBT : Subsurface Temperature

01/02/17

Current ocean conditions from ECMWF ocean data assimilation:

During January through mid-March 2015, near-to-below average SSTs were observed in the eastern Pacific, and positive SST anomalies persisted across the western and central Pacific. From June through September, the largest positive SST anomalies shifted westward. Generally, positive SST anomalies greater than 2°C remain east of the Date Line.

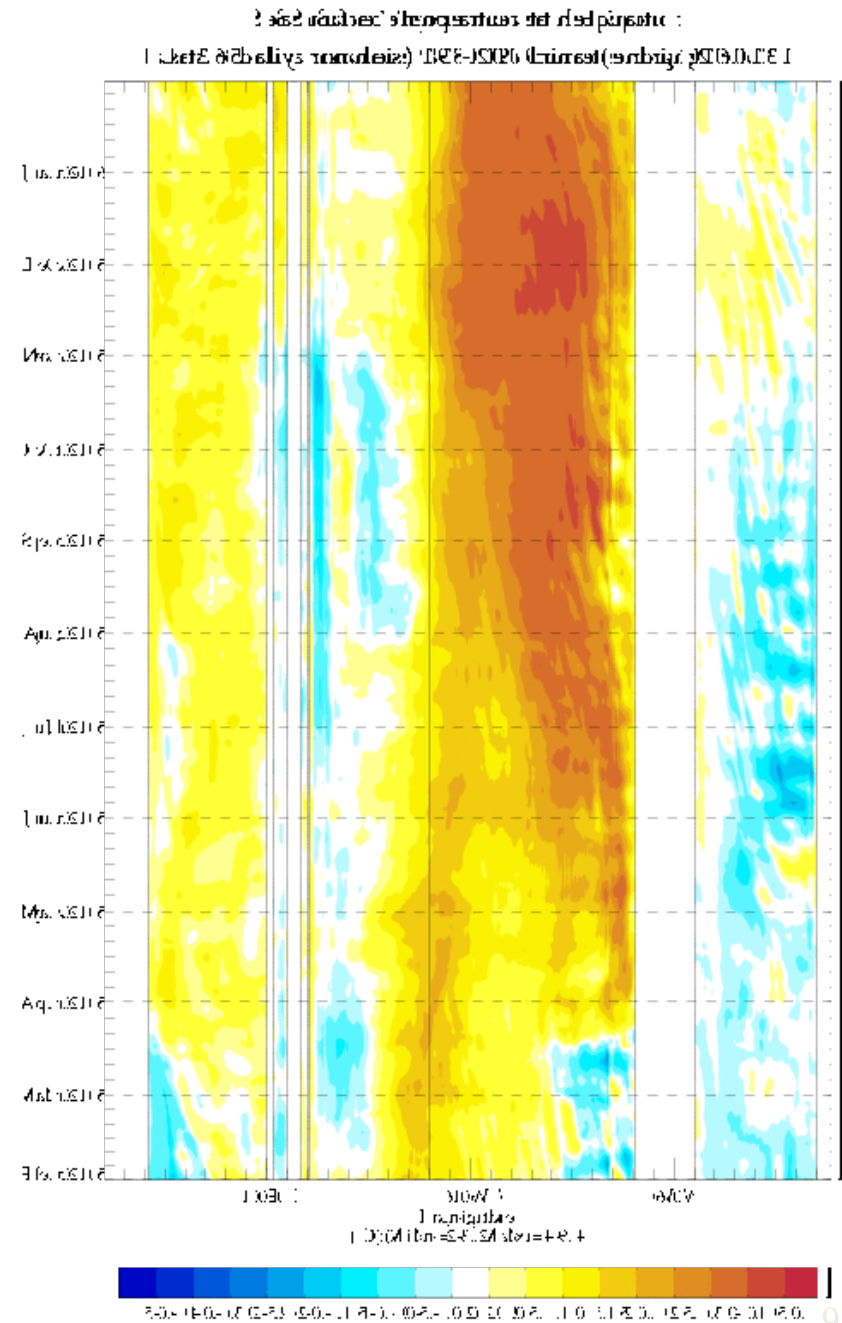

Current ocean conditions from ECMWF ocean data assimilation :

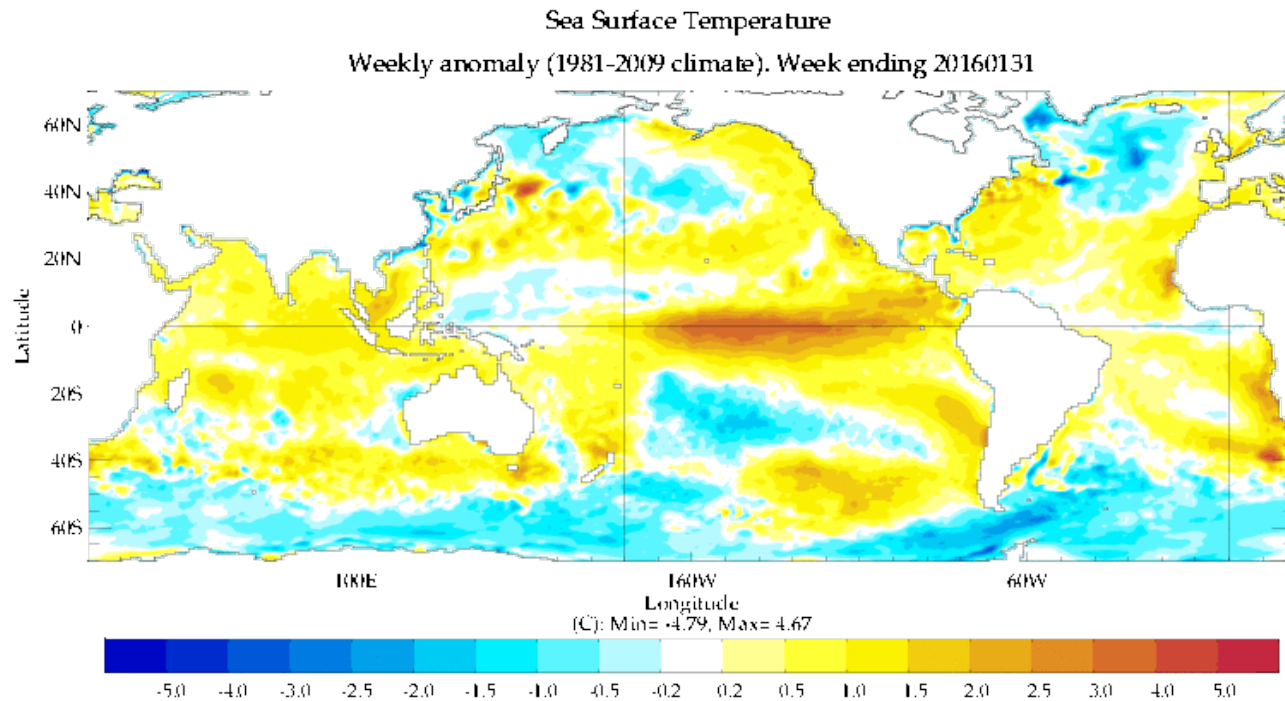

ECMWF Ocean Analysis & Real Time Jan 31 2016

Current ocean conditions from ECMWF ocean data assimilation :

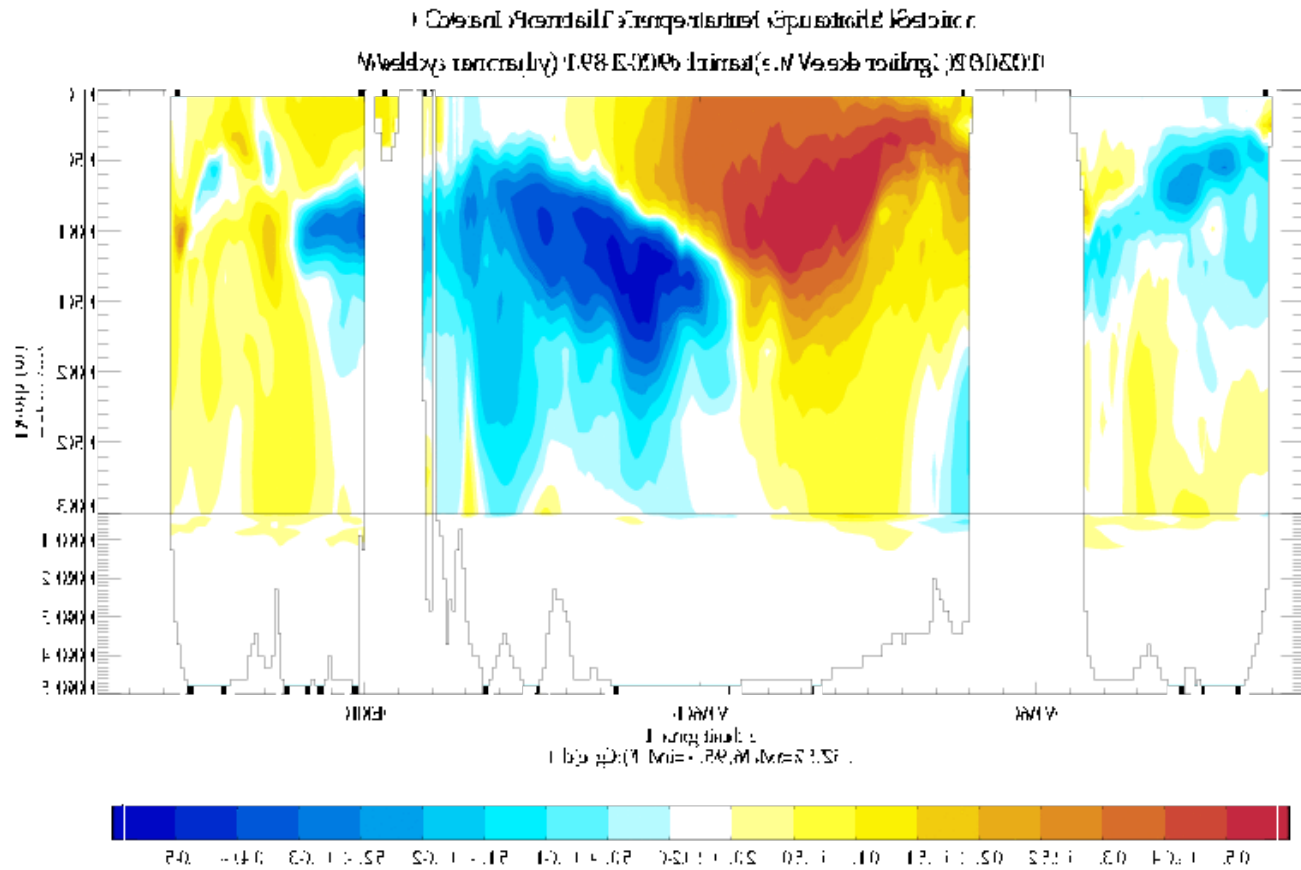

© 2017 ECMWF. All rights reserved.

SST anomalies

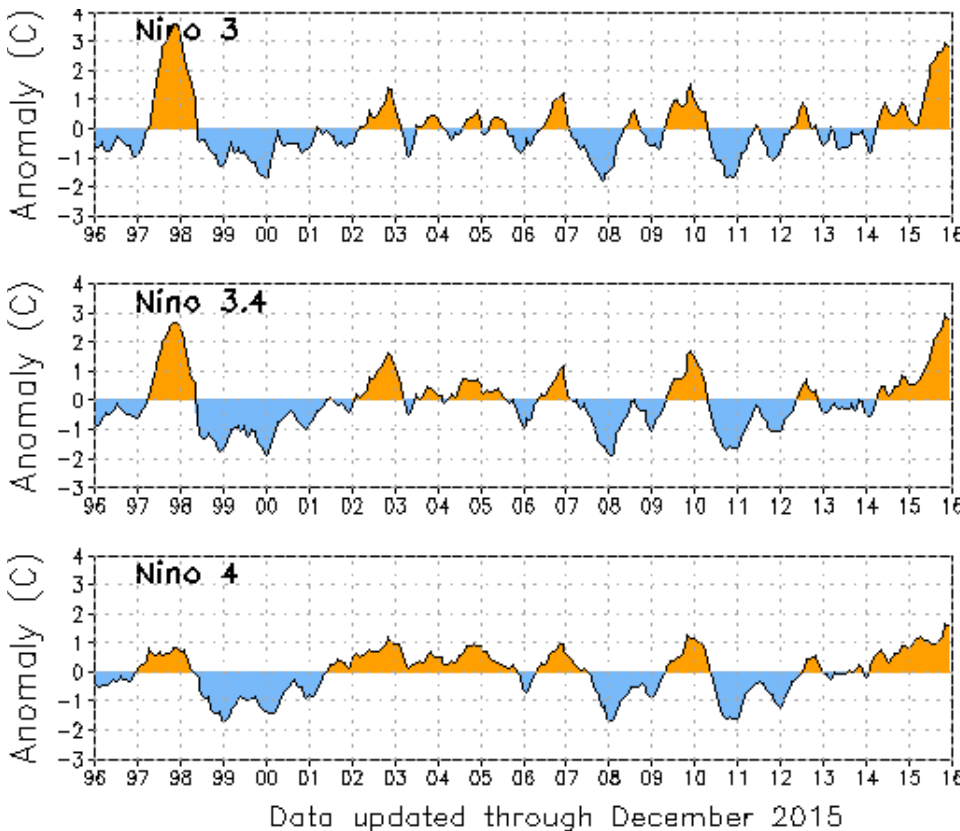
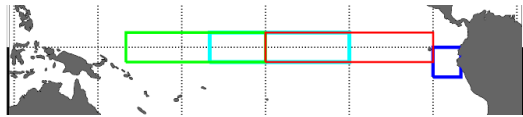

Southern Oscillation Index (SOI):

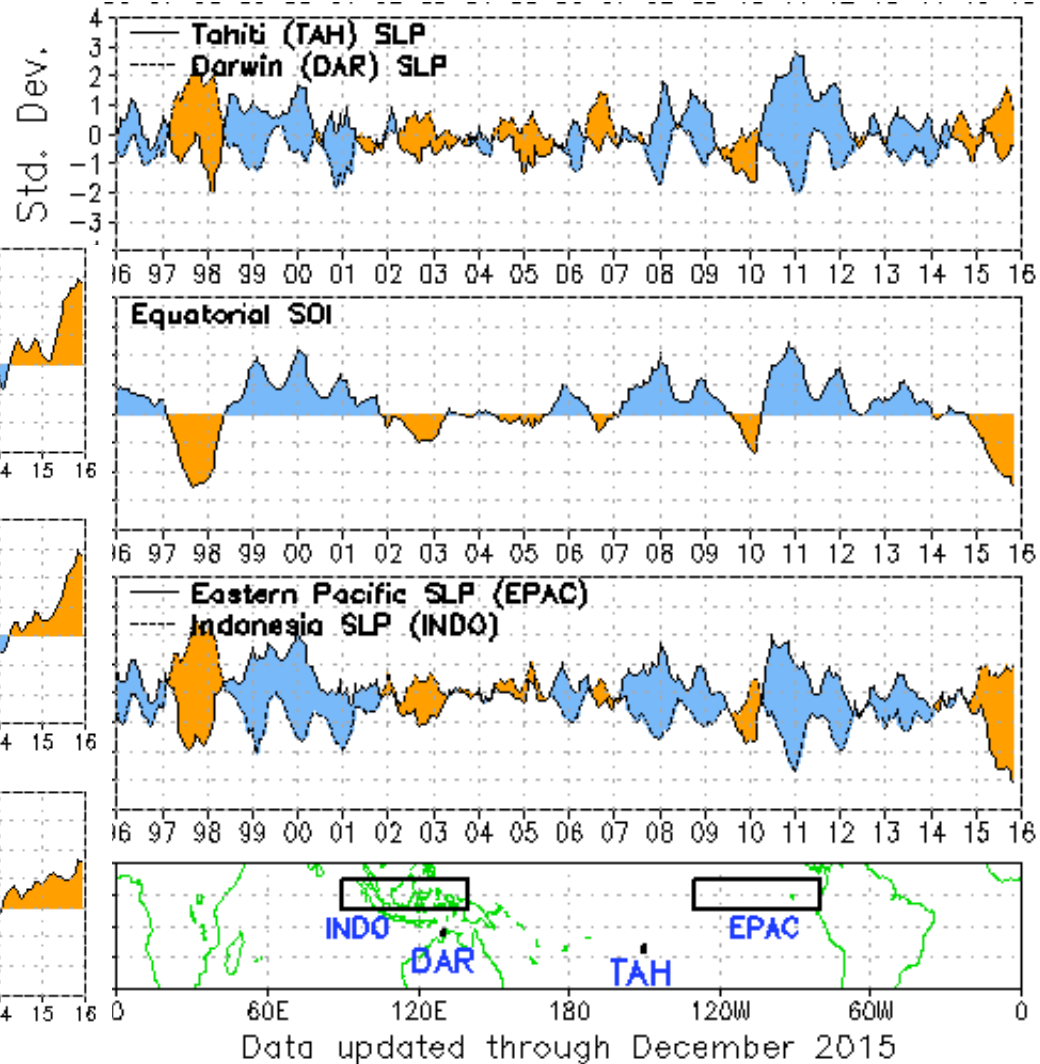

ECMWF System 4: main features

- **Operational forecasts**
 - **51-member ensemble from 1st day of the month**
 - **released on the 8th**
 - **7-month integration**
- **Re-forecast set**
 - **30 years, start dates from 1 Jan 1981 to 1 Dec 2010**
 - **15-member ensembles, 7-month integrations**
 - **13-month extension from 1st Feb/May/Aug/Nov**
- **Experimental ENSO outlook**
 - **13-month extension from 1st Feb/May/Aug/Nov**
 - **15-member ensemble**

Products :

- Ocean Analysis
- Seasonal outlook: (up to 7 months ahead)
 - Forecasts for Nino3, Nino3.4 and Nino4
 - Spatial plots (ens.mean anomaly, terciles ..)
 - Climagrams (similar to Epsgrams, teleconenction patterns)
 - Tropical storms

NINO3.4 plumes

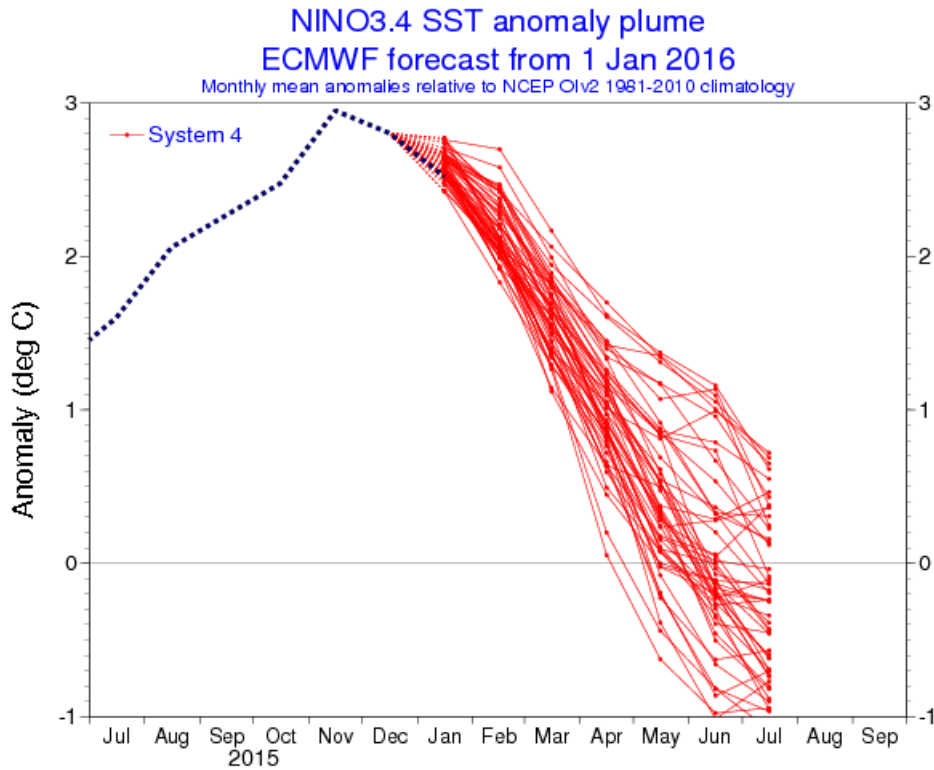

ECMWF

Nino3.4, Lon = [-170, -120], Lat = [-5, 5]
Nino12, Lon = [-90, -80], Lat = [-10, 0]
Nino4, Lon = [160, -150], Lat = [-5, 5]
Nino3, Lon = [-150, -90], Lat = [-5, 5]

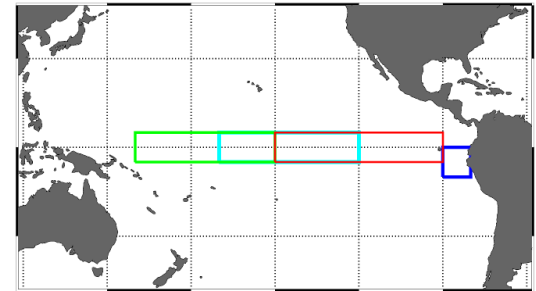

Forecast is made available on the 8h of each month

ENSO skill: comparison with other seasonal fc. systems

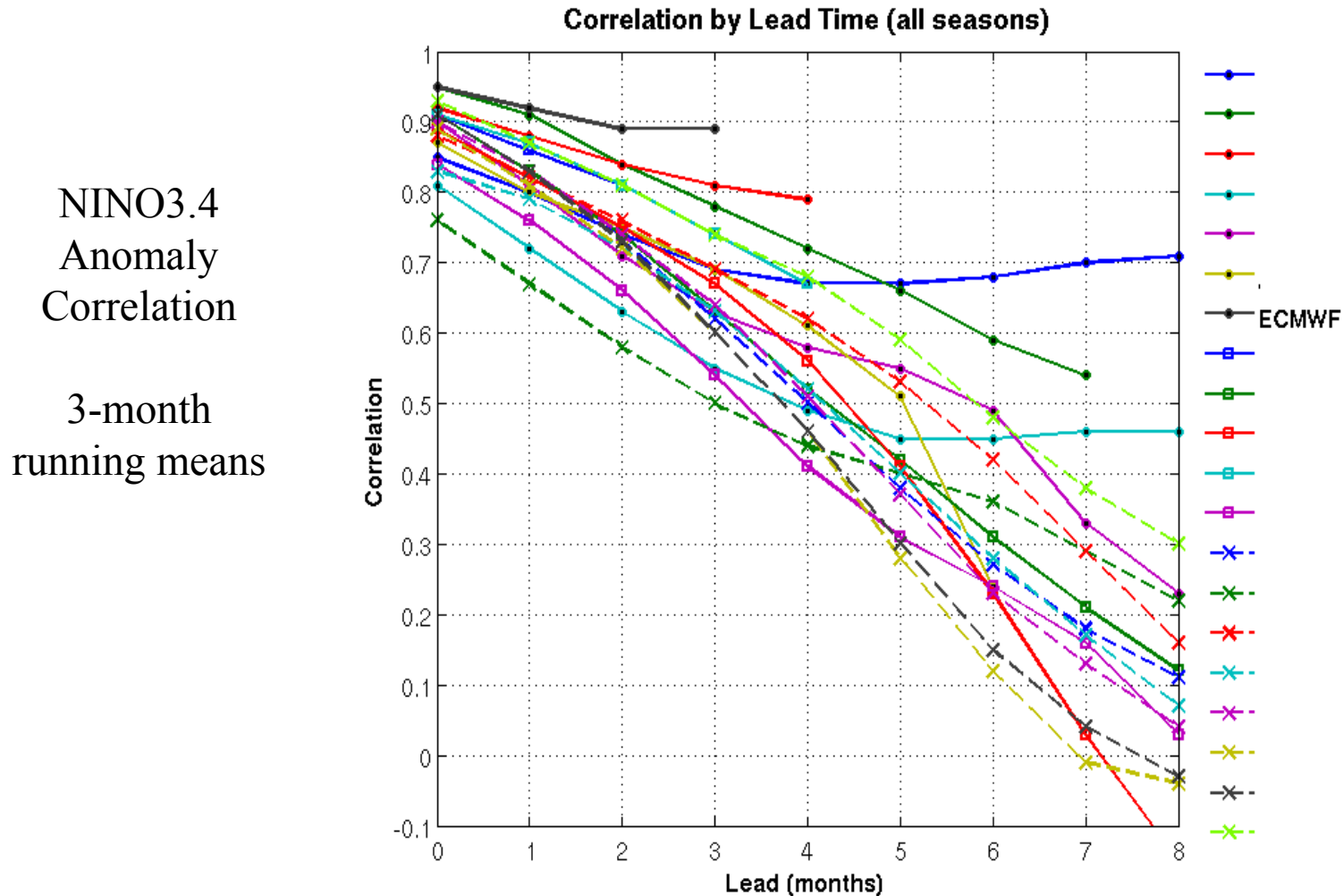

From: Barnston et al. 2011: Skill of Real-time Seasonal ENSO Model Predictions during 2002-2011—Is Our Capability Increasing? BAMS

EUROSIP multi-model system:

4 Coupled Systems: ECMWF, Météo France, Met Office, NCEP

- **Ensemble generation for the 4 systems is different**
- **Development of multi-model products is ongoing**
- **EUROSIP products are available to WMO users**

EUROSIP multi-model system:

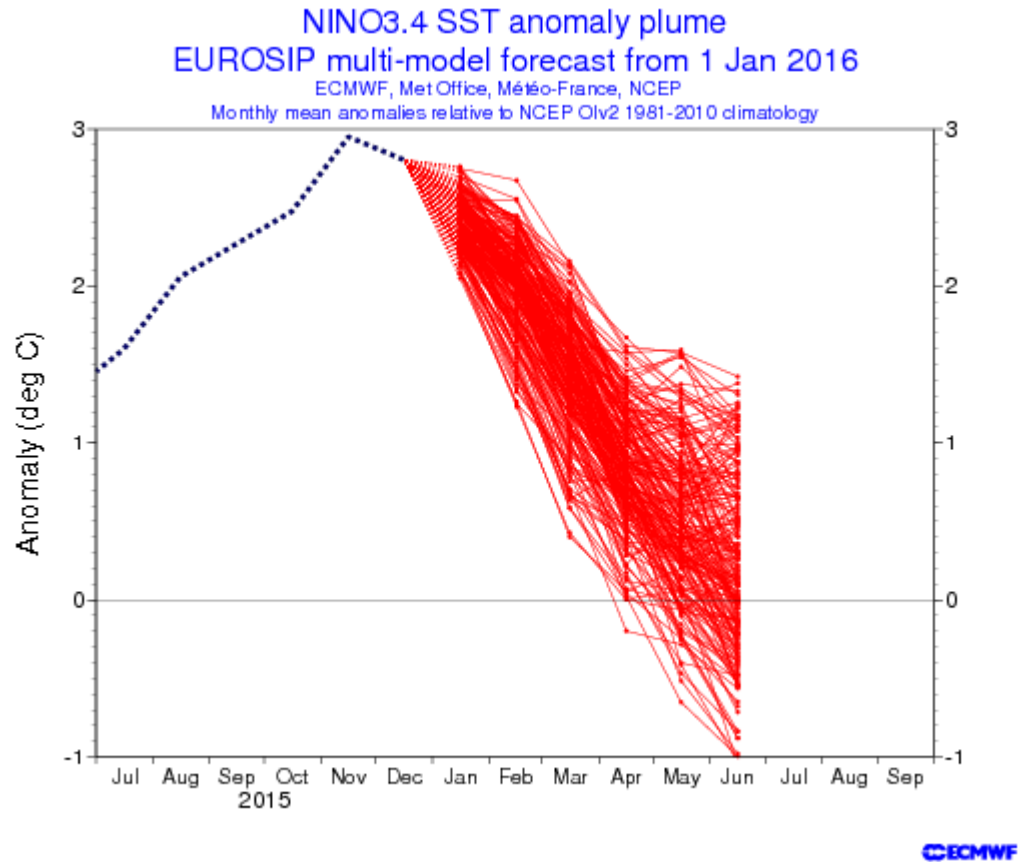
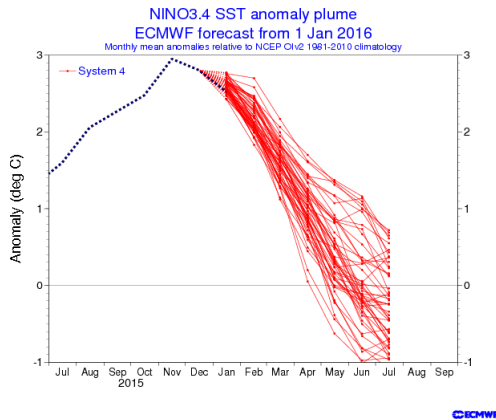

Nino3.4, Lon = [-170, -120], Lat = [-5, 5]
Nino12, Lon = [-90, -80], Lat = [-10, 0]
Nino4, Lon = [160, -150], Lat = [-5, 5]
Nino3, Lon = [-150, -90], Lat = [-5, 5]

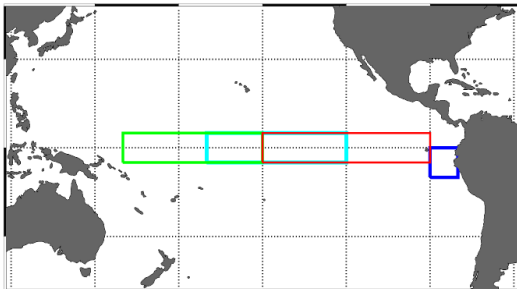

Eurosip is issued on the 15th of the month

Plumes for Nino 3.4

System 4

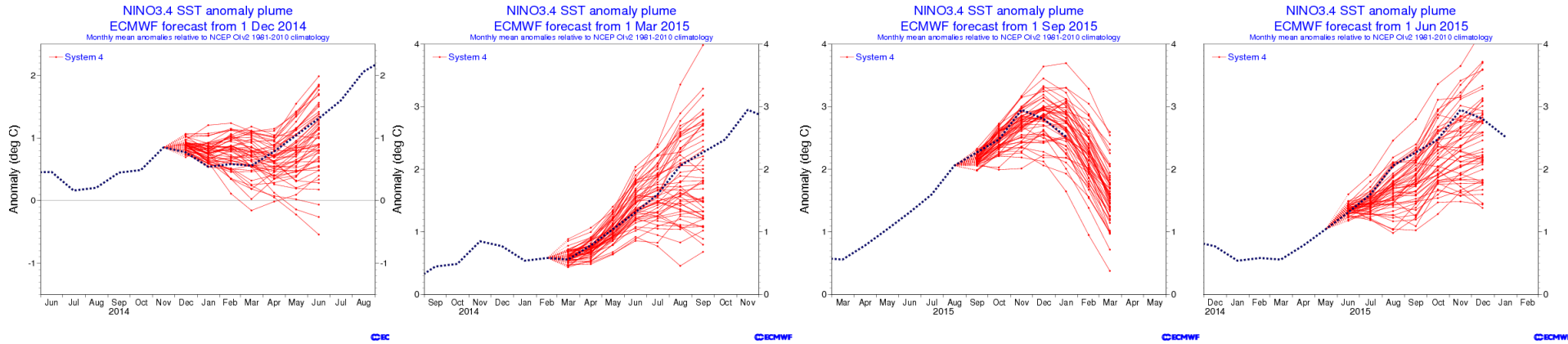

Eurosis

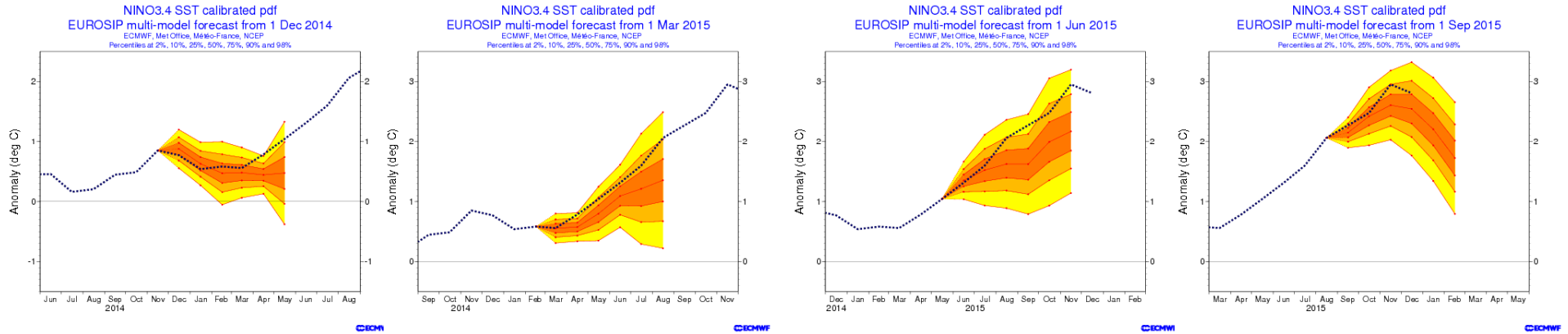

Global SST anomalies for August: 2015 versus 1997

2015

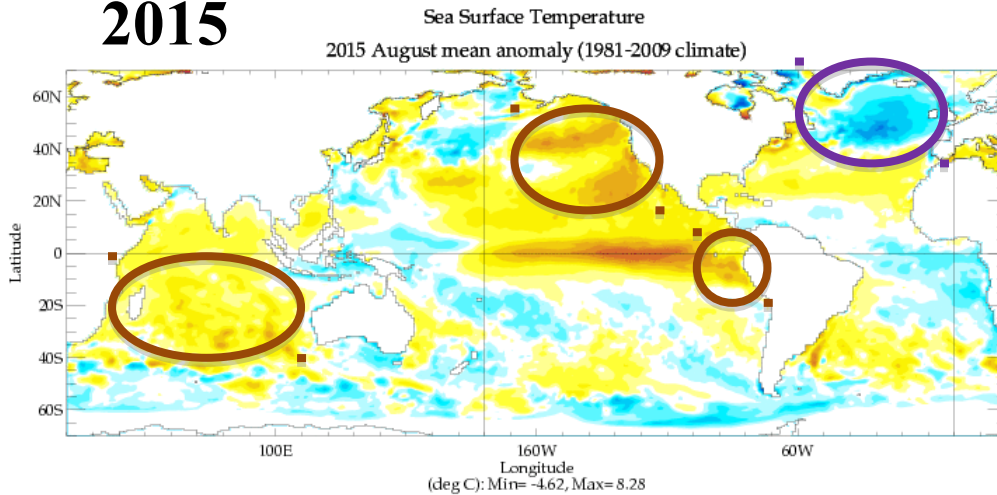

- Smaller anomalies over the pacific East coast (Nino1+2)
- Warm SST over the Pacific (40-15N) Eastern Pacific.

1997

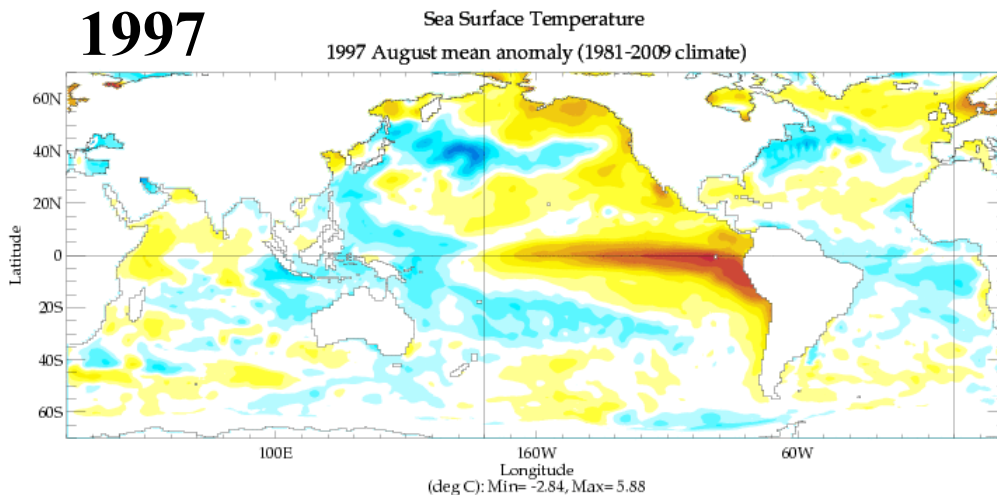

- Cold SST anomalies over the mid-lat. Atlantic likely to affect the ENSO teleconnection over Europe.

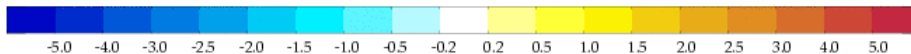

Extended forecasts range performance for JJA 2015:

ECMWF Seasonal Forecast
 Mean forecast SST anomaly
 Forecast start reference is 01/05/15
 Ensemble size = 51, climate size = 450

System 4
 JJA 2015

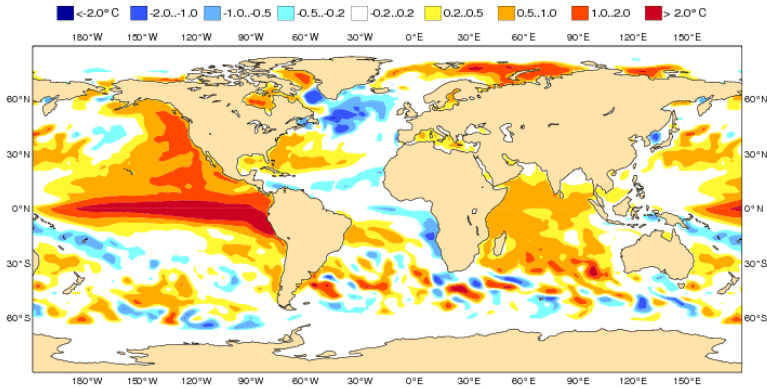

SST anomalies

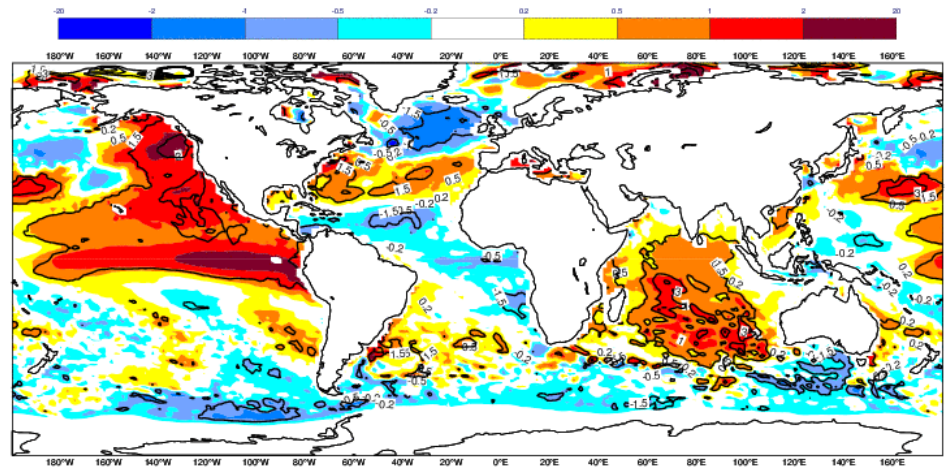

EUROSIP multi-model seasonal forecast
 Mean forecast SST anomaly
 Forecast start reference is 01/05/15
 Variance-standardized mean

ECMWF/Met Office/Meteo-France/NCEP
 JJA 2015

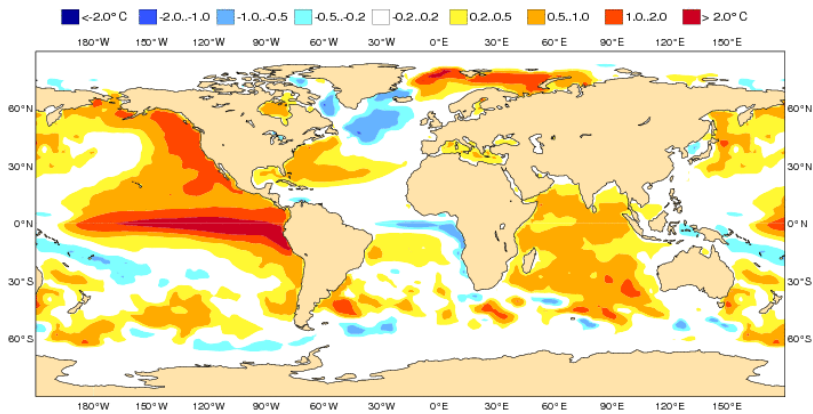

Seasonal forecast SON : 2-metre temperature anomalies

ECMWF Seasonal Forecast
 Mean 2m temperature anomaly
 Forecast start reference is 01/08/15
 Ensemble size = 51, climate size = 450

System 4
 SON 2015
 Shaded areas significant at 10% level
 Solid contour at 1% level

Observed

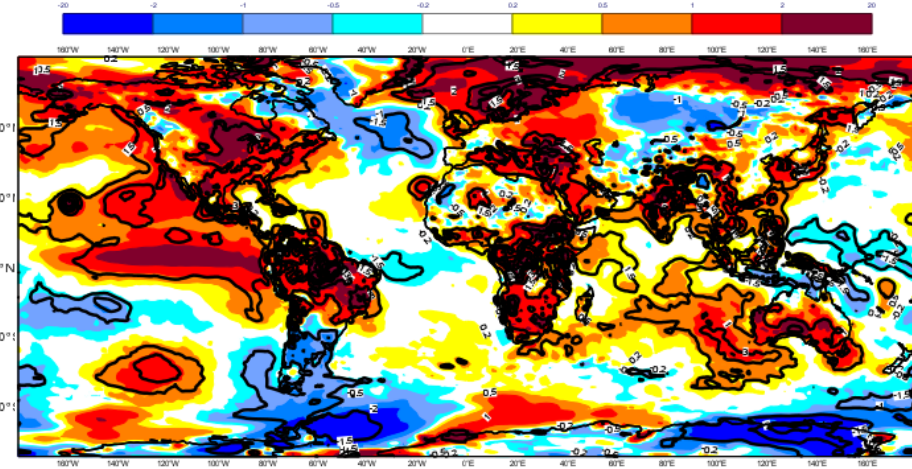
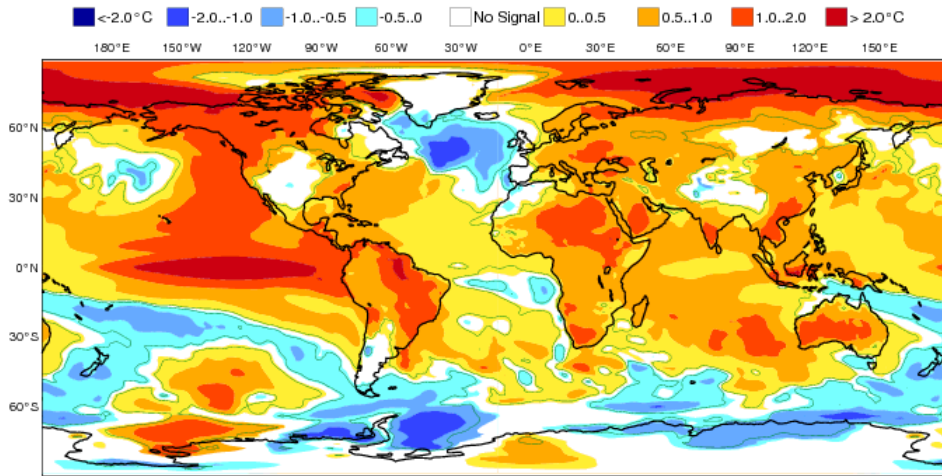

EUROSIP multi-model seasonal forecast
 Mean 2m temperature anomaly
 Forecast start reference is 01/08/15
 Variance-standardized mean

ECMWF/Met Office/Meteo-France/NCEP
 SON 2015

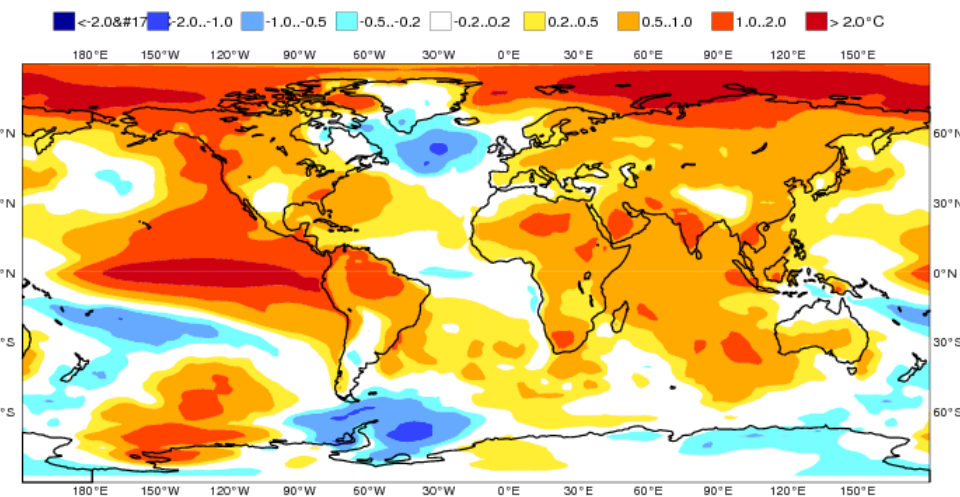

Extended forecasts range performance for NDJ 2016:

2mtemp anomalies

ECMWF Seasonal Forecast
Mean 2m temperature anomaly
Forecast start reference is 01/10/15
Ensemble size = 51, climate size = 450

System 4
NDJ 2015/16
Shaded areas significant at 10% level
Solid contour at 1% level

■ <-2.0
■ -2.0...-1.0
■ -1.0...-0.5
■ -0.5...0
■ No Signal
■ 0...0.5
■ 0.5...1.0
■ 1.0...2.0
■ > 2.0 °C

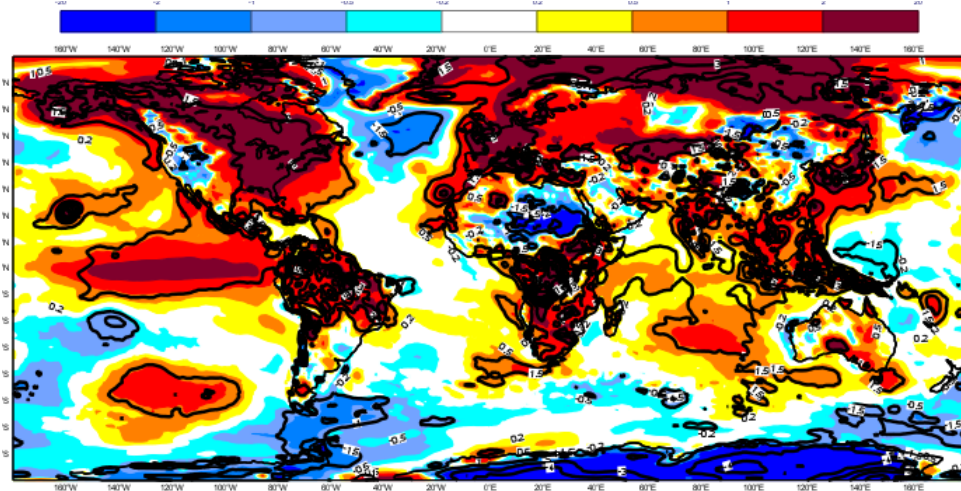
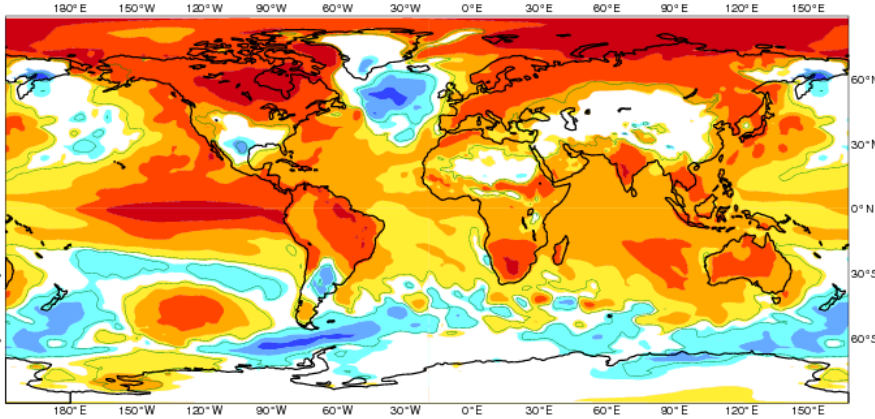

EUROSIP multi-model seasonal forecast
Mean 2m temperature anomaly
Forecast start reference is 01/10/15
Variance-standardized mean

ECMWF/Met Office/Meteo-France/NCEP
NDJ 2015/16

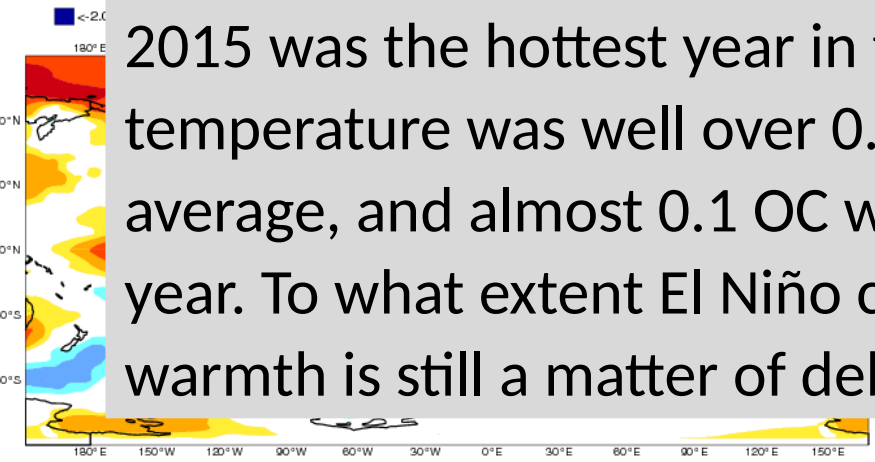

2015 was the hottest year in the modern record, global temperature was well over 0.4 °C warmer than the 1981-2010 average, and almost 0.1 °C warmer than the previous warmest year. To what extent El Niño contributed to the record-breaking warmth is still a matter of debate.

2m temp anomalies for Europe

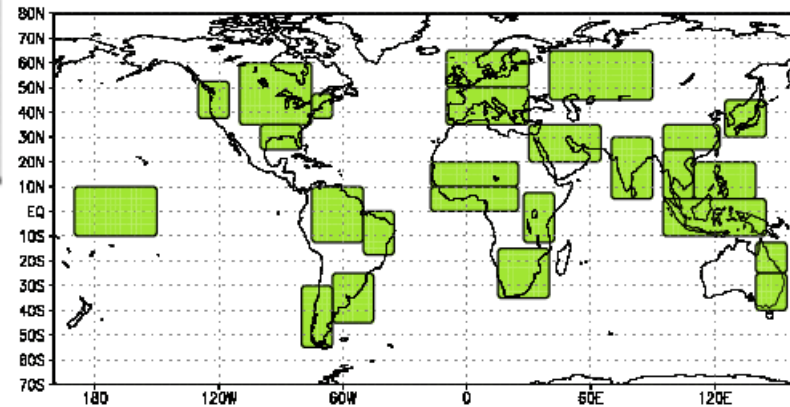
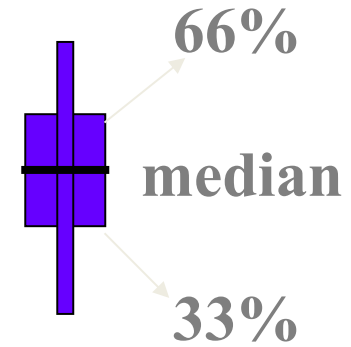
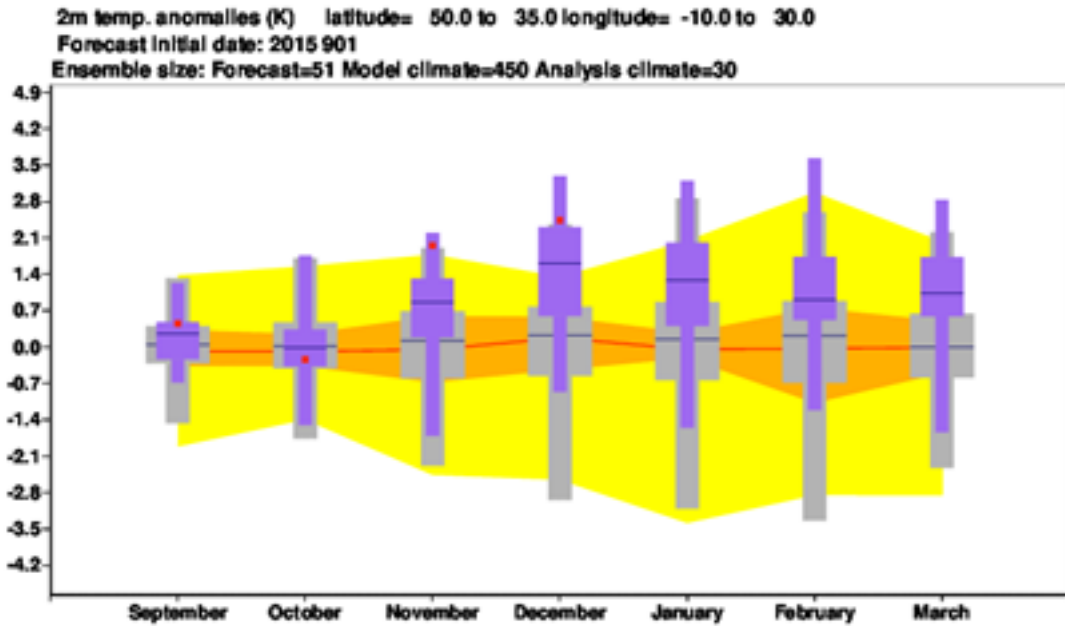

Outlook for Europe

Long-term predictions over Europe are particularly difficult:

- At times during very large El Niño part of Europe seem to be affected.
- However non-linearity of the atmosphere seem to play a relevant role over this region.
- The Atlantic Ocean influence on the weather over Europe is not yet well understood.

Seasonal forecast charts :

Spatial maps representing the seasonal forecast in terms of model probabilities stratified by terciles.

ECMWF Seasonal Forecast
Prob(most likely category of 2m temperature)
Forecast start reference is 01/01/16
Ensemble size = 51, climate size = 450

System 4
FMA 2016

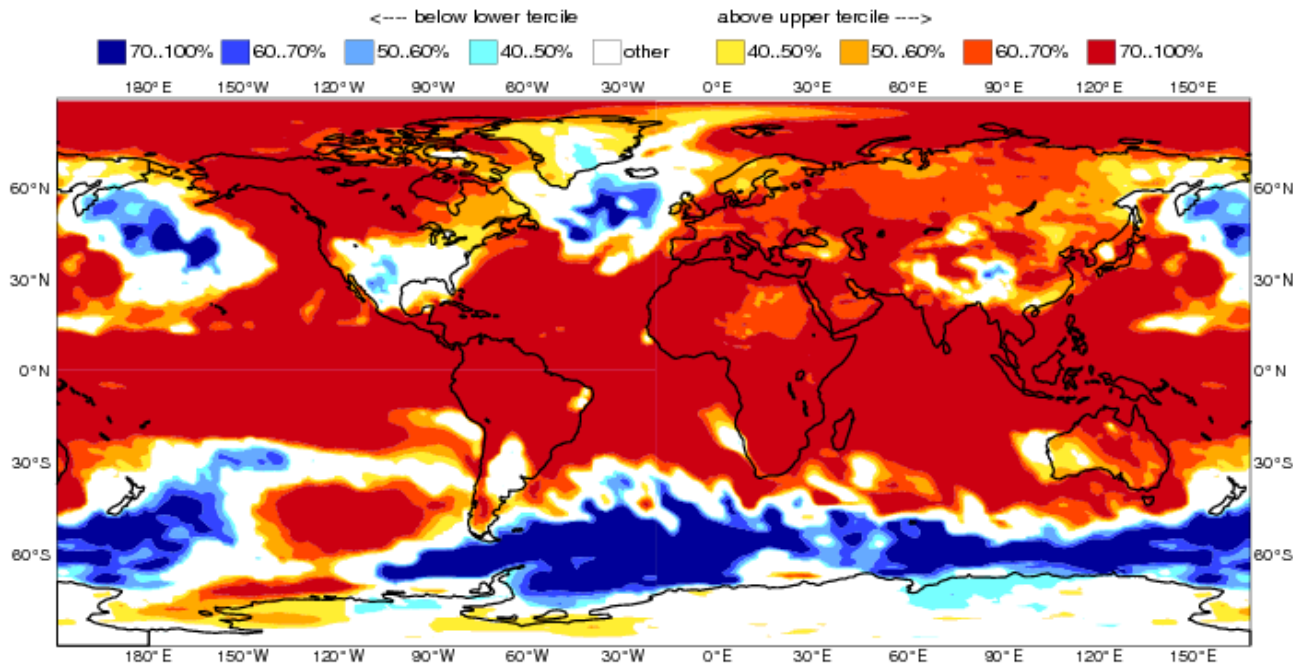

Available parameters are:

- 2m Temperature
- Mean sea level pressure
- Precipitation
- Sea surface temperature
- 850 hPa temperature
- 500 hPa geopotential

Seasonal forecast charts :

Spatial maps representing the seasonal forecast in terms of model probabilities stratified by terciles.

ECMWF Seasonal Forecast
Mean 2m temperature anomaly
Forecast start reference is 01/01/16
Ensemble size = 51, climate size = 450

System 4
FMA 2016
Shaded areas significant at 10% level
Solid contour at 1% level

Available parameters are:

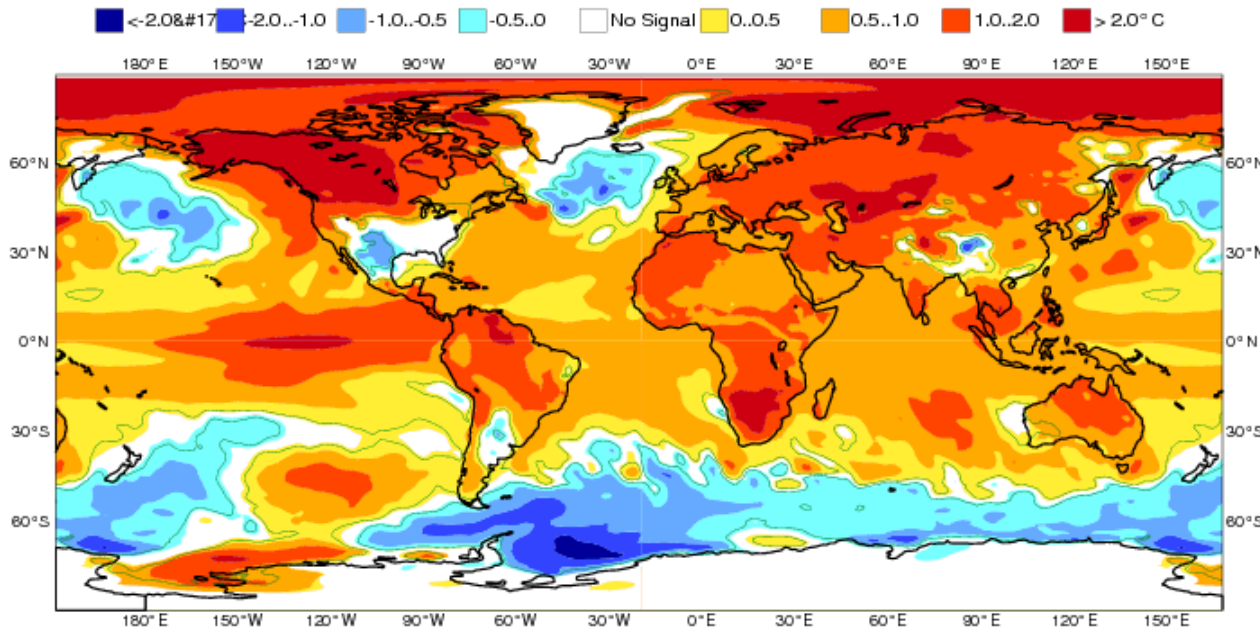

- 2m Temperature
- Mean sea level pressure
- Precipitation
- Sea surface temperature
- 850 hPa temperature
- 500 hPa geopotential

Reliability: 2m T > upper tercile over Europe, JJA

Sys 4

Reliability diagram for ECMWF with 15 ensemble members
Near-surface air temperature anomalies above the upper tercile
Accumulated over Europe (land and sea points)
Hindcast period 1981-2010 with start in May average over months 2 to 4
Skill scores and 95% conf. intervals (1000 samples)
Brier skill score: 0.092 (0.007, 0.162)
Reliability skill score: 0.986 (0.950, 0.994)
Resolution skill score: 0.106 (0.056, 0.173)

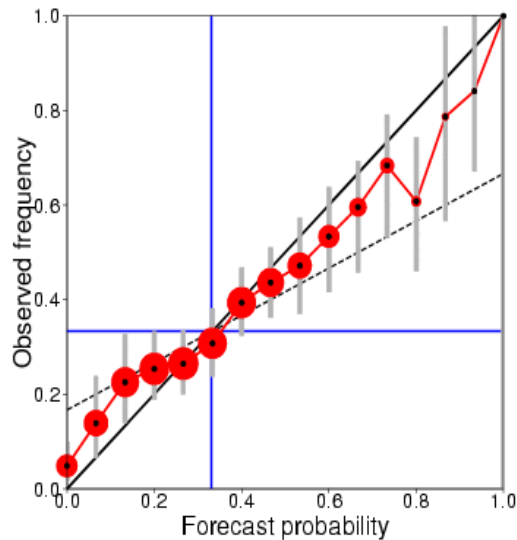

Sys 3

Reliability diagram for ECMWF with 11 ensemble members
Near-surface air temperature anomalies above the upper tercile
Accumulated over Europe (land and sea points)
Hindcast period 1981-2010 with start in May average over months 2 to 4
Skill scores and 95% conf. intervals (1000 samples)
Brier skill score: 0.031 (-0.045, 0.094)
Reliability skill score: 0.943 (0.891, 0.965)
Resolution skill score: 0.089 (0.056, 0.133)

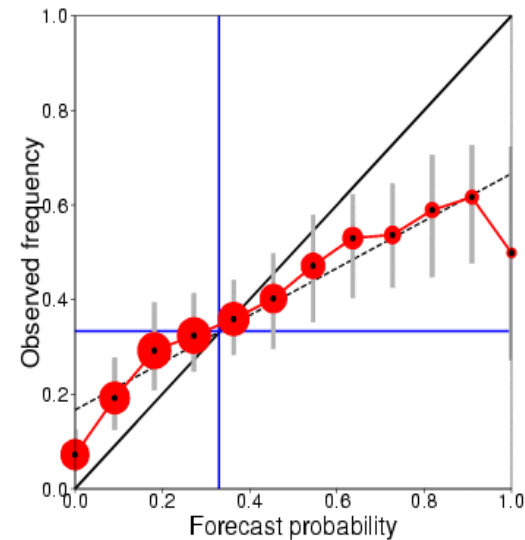

Validation :

- Documentation of skill levels is provided to the users:
 - The measure of skill conforms to a common standard defined by the WMO
 - The verification sampling for seasonal forecast is limited, importance of significance levels in the verification statistics



Two metre temperature and 30m w

About Us

Overview
Getting here
Committees

Products

Forecasts
Order Data
Order Software

Services

Computing
Archive
PrepFS

Research

Modelling
Reanalysis
Seasonal

Publications

Newsletters
Manuals
Library

News&Events

Calendar
Employment
Open Tenders

Home > Products > Forecasts > Seasonal > Forecast > Seasonal range forecast > 2m temperature >

2m temperature

Parameter

- 2m temperature**
- mean sea level
- pressure
- rain
- sea surface temperature
- 850 hPa temperature
- 500 hPa geopotential

Month

- Jan 2014
- Jan 2014**
- Dec 2013
- Nov 2013
- Oct 2013
- Sep 2013
- Aug 2013
- ...

Your Room

Add this product

Show overview

- Lead time
- Area
- Month
- Forecast type and skill measures

Download...

- PDF (613.2 Kbytes)
- Postscript (1.2 Mbytes)

Lead time: two months lead time
 Area: Global
 Forecast type and skill measures: tercile summary

ECMWF Seasonal Forecast
 Prob(most likely category of 2m temp
 Forecast start reference is 01/01/15
 Ensemble size - 51, climate size - 450

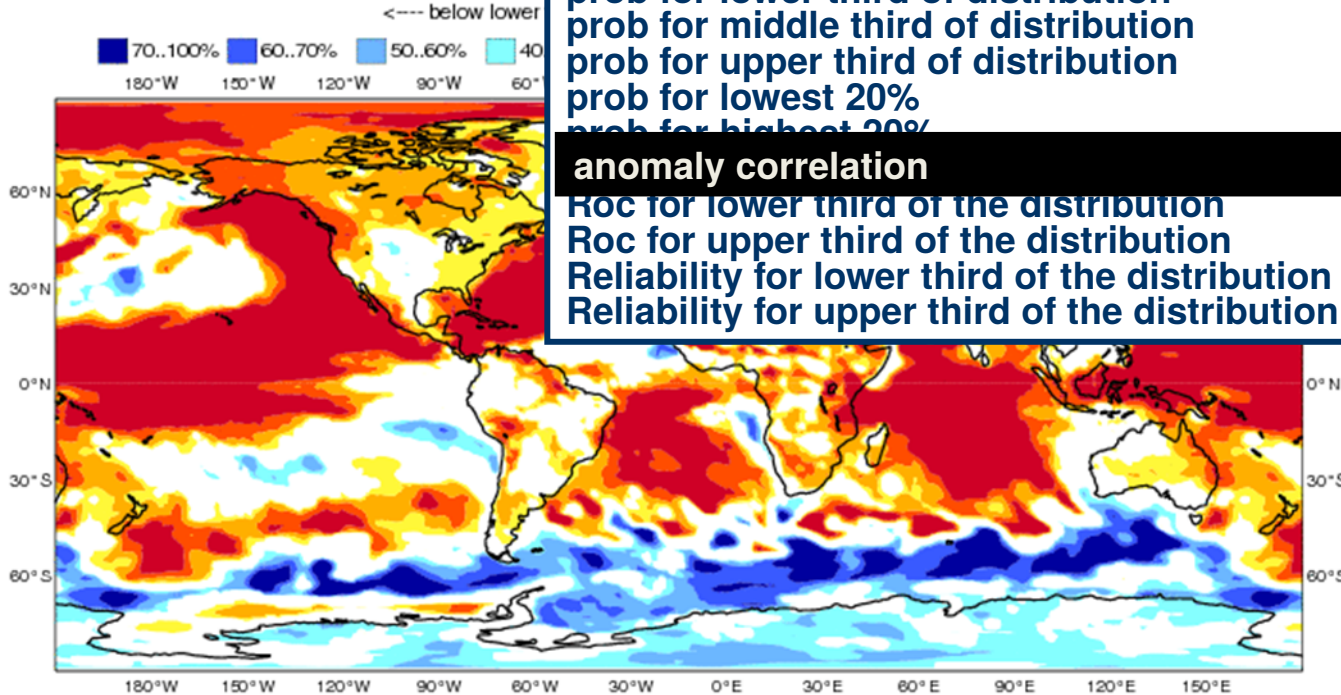

tercile summary
 ensemble mean
 prob exceeding median
 prob for lower third of distribution
 prob for middle third of distribution
 prob for upper third of distribution
 prob for lowest 20%
 prob for highest 20%

anomaly correlation
 Roc for lower third of the distribution
 Roc for upper third of the distribution
 Reliability for lower third of the distribution
 Reliability for upper third of the distribution



About Us

Overview
Getting here
Committees

Products

Forecasts
Order Data
Order Software

Services

Computing
Archive
PreplFS

Research

Modelling
Reanalysis
Seasonal

Publications

Newsletters
Manuals
Library

News&Events

Calendar
Employment
Open Tenders

Home > Products > Forecasts > Seasonal > Forecast > Seasonal range forecast > 2m temperature >

2m temperature

Parameter

- [2m temperature](#)
- [mean sea level](#)
- [pressure](#)
- [rain](#)
- [sea surface temperature](#)
- [850 hPa temperature](#)
- [500 hPa geopotential](#)

Month

- Jan 2014
- [Jan 2014](#)
- [Dec 2013](#)
- [Nov 2013](#)
- [Oct 2013](#)
- [Sep 2013](#)
- [Aug 2013](#)
- ...

Your Room

[Add this product](#)

Show overview

- [Lead time](#)
- [Area](#)
- [Month](#)
- [Forecast type and skill measures](#)

Download...

- PDF (344.3 Kbytes)
- Postscript (373.3 Kbytes)

Lead time Area Forecast type and skill measures

Anomaly Co
Near-surface
Hindcast pe
Black dots f

- Global Tropics
- Europe
- Africa
- East Asia
- Asia
- Australasia
- North America
- South America

- tercile summary
- ensemble mean
- prob exceeding median
- prob for lower third of distribution
- prob for middle third of distribution
- prob for upper third of distribution
- prob for lowest 20%
- prob for highest 20%
- anomaly correlation
- Roc for lower third of the distribution
- Roc for upper third of the distribution
- Reliability for upper third of the distribution

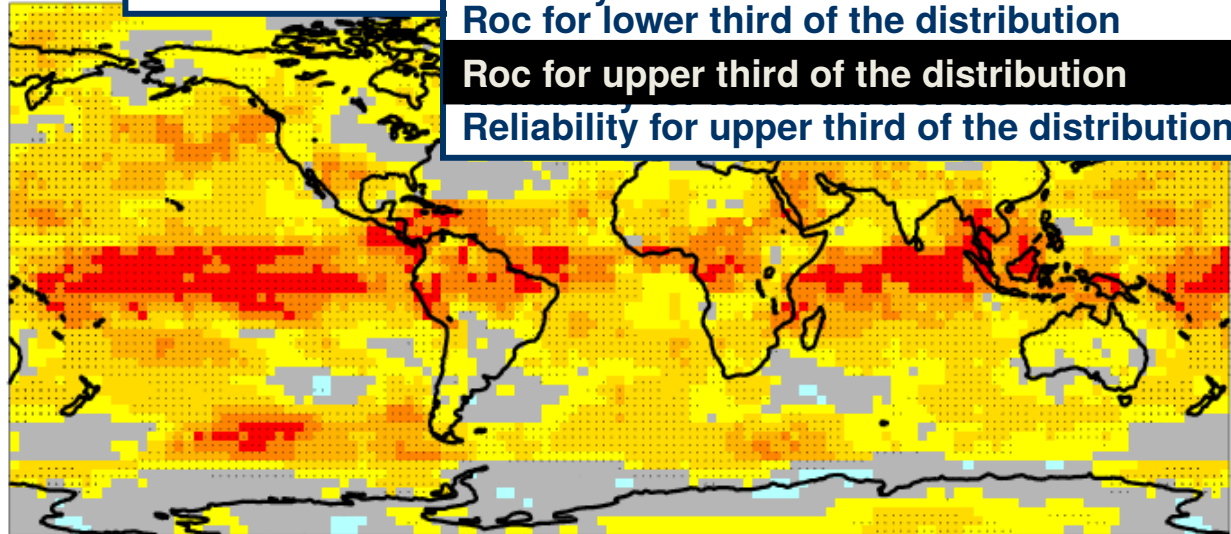

Reliability for summer predictions: warm events

Europe

Reliability diagram for ECMWF with 15 ensemble members
Near-surface air temperature anomalies below the lower tercile
Accumulated over Europe (land and sea points)
Hindcast period 1981-2010 with start in May average over months 2 to 4
Skill scores and 95% conf. intervals (1000 samples)
Brier skill score: 0.108 (0.009, 0.183)
Reliability skill score: 0.980 (0.921, 0.991)
Resolution skill score: 0.128 (0.072, 0.203)

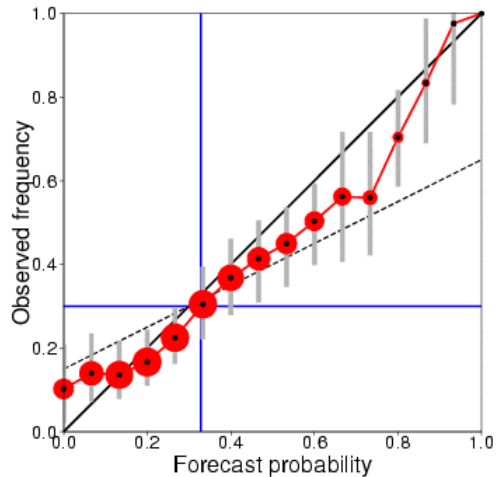

Tropics

Reliability diagram for ECMWF with 15 ensemble members
Near-surface air temperature anomalies below the lower tercile
Accumulated over tropical band (land and sea points)
Hindcast period 1981-2010 with start in May average over months 2 to 4
Skill scores and 95% conf. intervals (1000 samples)
Brier skill score: 0.214 (0.146, 0.279)
Reliability skill score: 0.949 (0.925, 0.965)
Resolution skill score: 0.266 (0.211, 0.322)

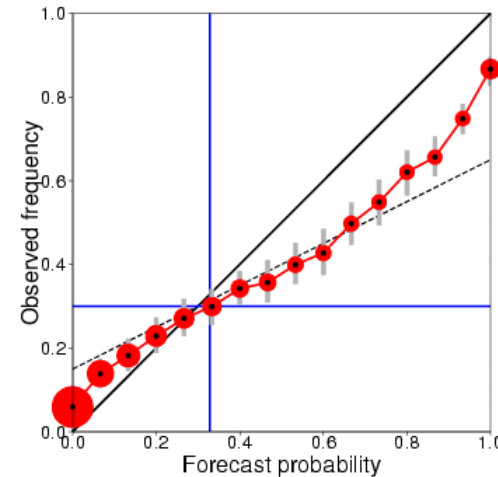

Reliability for winter predictions : cold event

Europe

Reliability diagram for ECMWF with 15 ensemble members
Near-surface air temperature anomalies below the lower tercile
Accumulated over Europe (land and sea points)
Hindcast period 1981-2010 with start in November average over months 2 to 4
Skill scores and 95% conf. intervals (1000 samples)
Brier skill score: -0.053 (-0.177, 0.032)
Reliability skill score: 0.929 (0.810, 0.969)
Resolution skill score: 0.018 (0.008, 0.068)

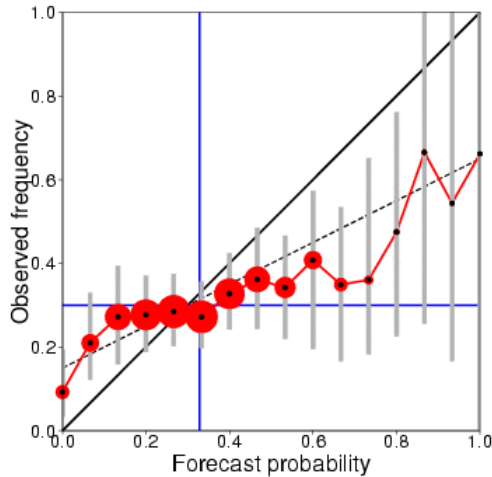

Tropics

Reliability diagram for ECMWF with 15 ensemble members
Near-surface air temperature anomalies below the lower tercile
Accumulated over tropical band (land and sea points)
Hindcast period 1981-2010 with start in November average over months 2 to 4
Skill scores and 95% conf. intervals (1000 samples)
Brier skill score: 0.248 (0.175, 0.311)
Reliability skill score: 0.964 (0.942, 0.978)
Resolution skill score: 0.284 (0.225, 0.338)

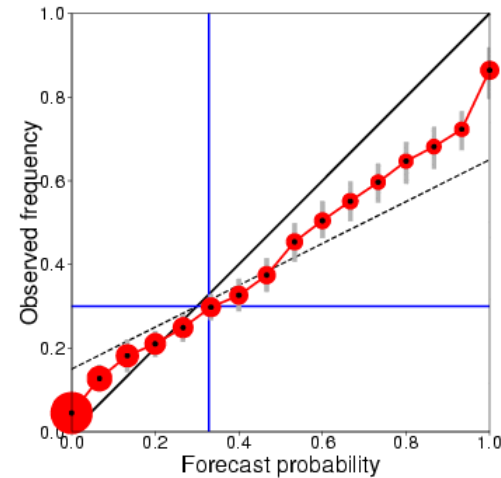

ECMWF Seasonal Forecast Hurricane or typhoon Frequency

Forecast start reference is 01/01/2015
Ensemble size = 51, climate size = 300

System 4
FMAMJJ 2015

Climate (initial dates) = 1990-2009

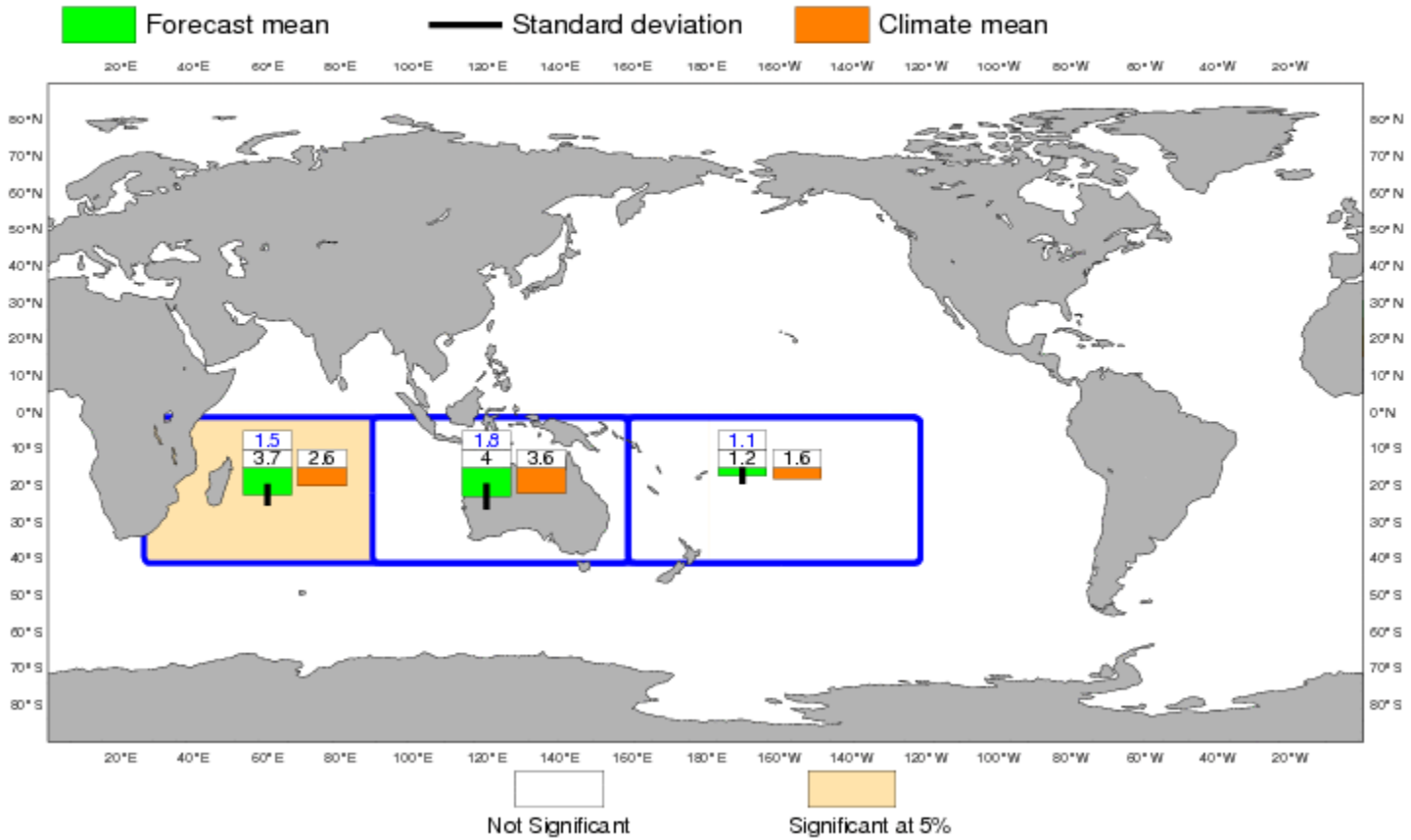

Prediction of tropical cyclone frequency: NW Pacific

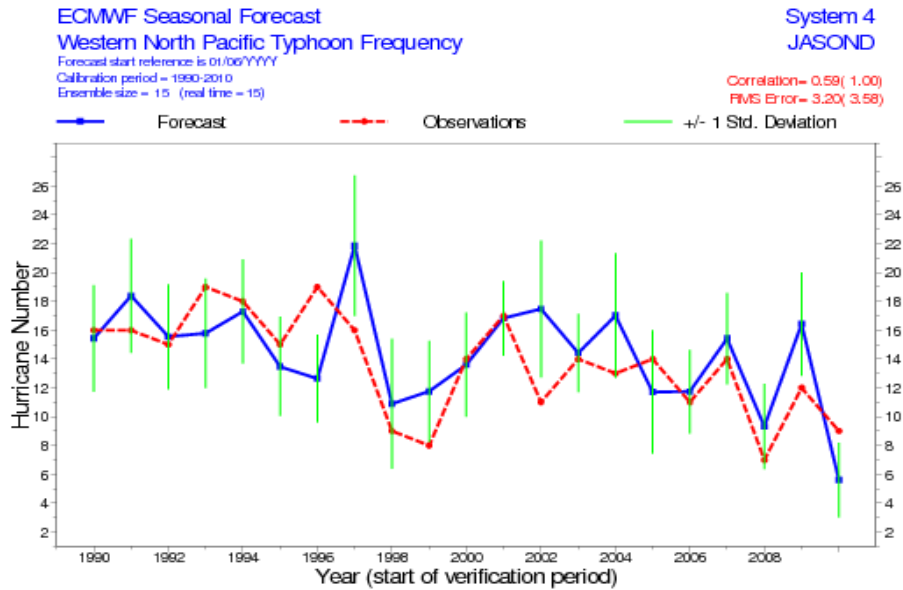

System 4
vs. ERA-Int.

July-Dec.
1990-2010

System 3
vs. ERA-Int.

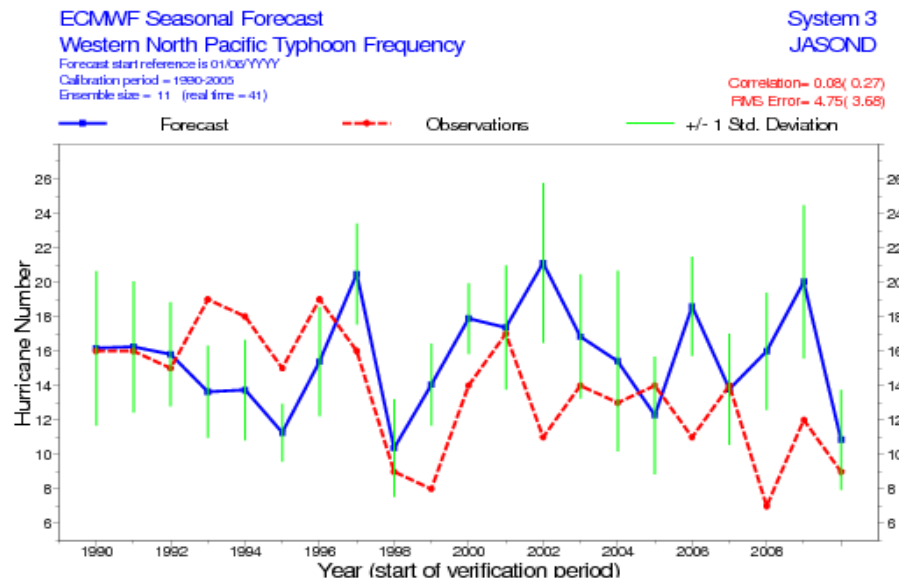

Climagrams : teleconnections indices NAO

North Atlantic Oscillation

Forecast initial date: 2013 101

Ensemble size: Forecast=51 Model climate=450 Analysis climate=30

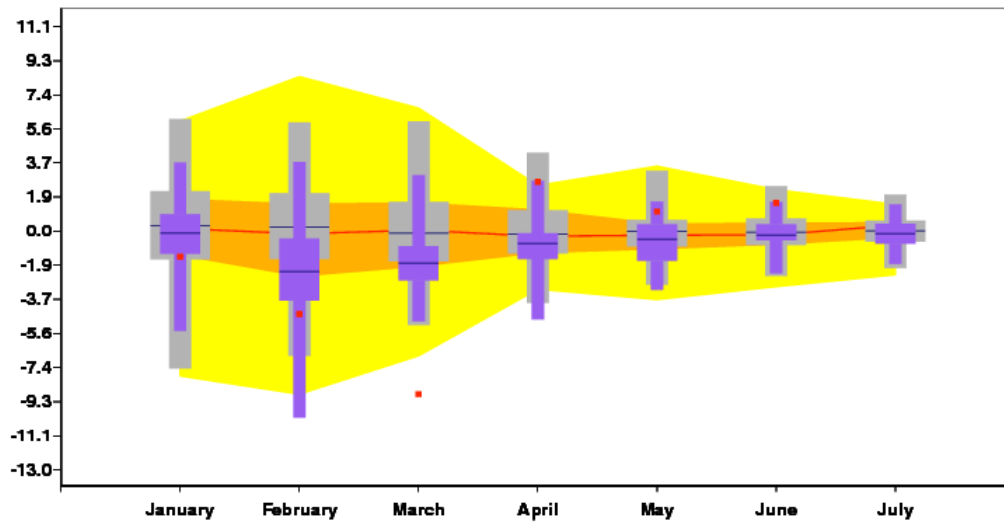

eof 1: North Atlantic Oscillation (NAO)

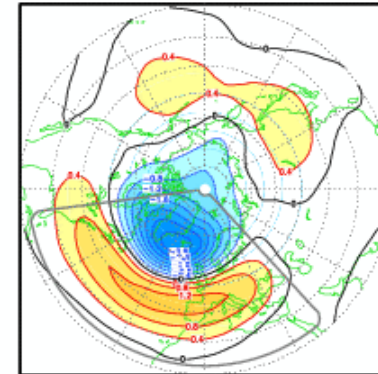

North Atlantic Oscillation

Forecast initial date: 20121201

Ensemble size: Forecast=51 Model climate=450 Analysis climate=30

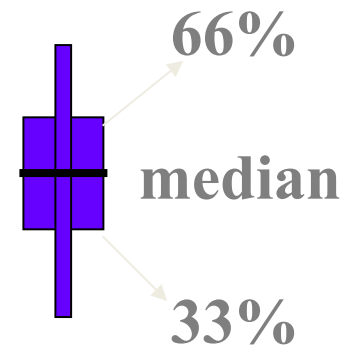
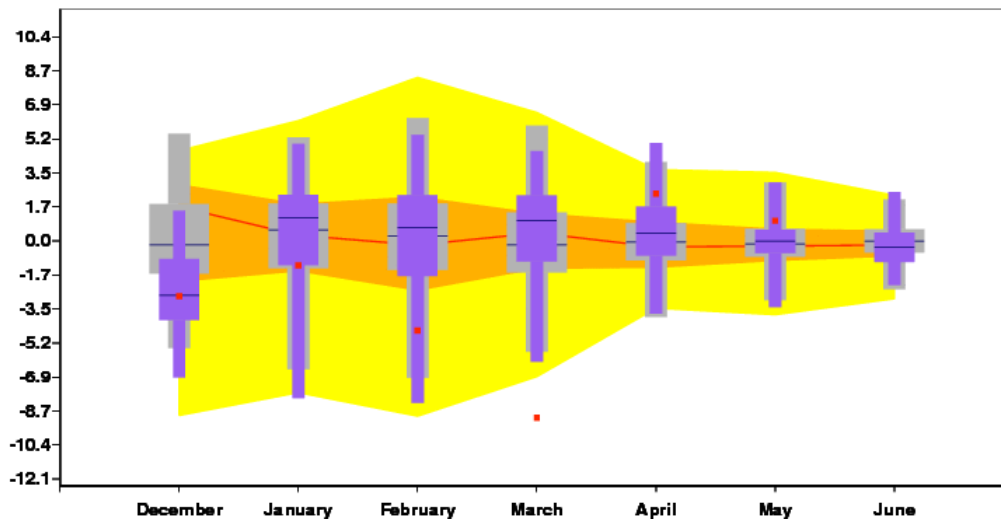

Summary (2)

- The current operational seasonal forecast system provides a set graphic products on the web and digital data set to the users.
- The ECMWF seasonal forecast is a good system for El Nino predictions.
- Seasonal forecast predictions, particularly over mid-latitudes, should be used in combination with some estimate of the forecast skill. Various skill estimates are available to the users.
- Multi-model approach: a way to deal with model error (model calibration) and to enhance forecast reliability.
- For further reading see ECMWF Tech Memo N.656, available at <http://www.ecmwf.int/publications>

ECMWF Seasonal Forecast
 Prob(most likely category of 2m temperature)
 Forecast start reference is 01/01/16
 Ensemble size = 51, climate size = 450

System 4
 FMA 2016

EUROSIP 2mt predictions:

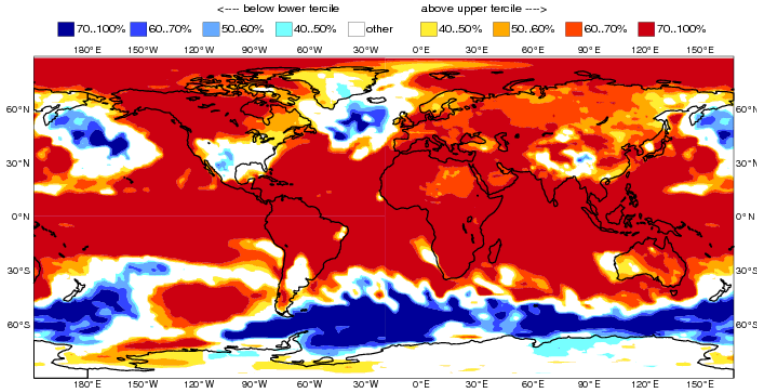

EUROSIP multi-model seasonal forecast
 Prob(most likely category of 2m temperature)
 Forecast start reference is 01/01/16
 Unweighted mean

ECMWF/Met Office/Meteo-France/NCEP
 FMA 2016

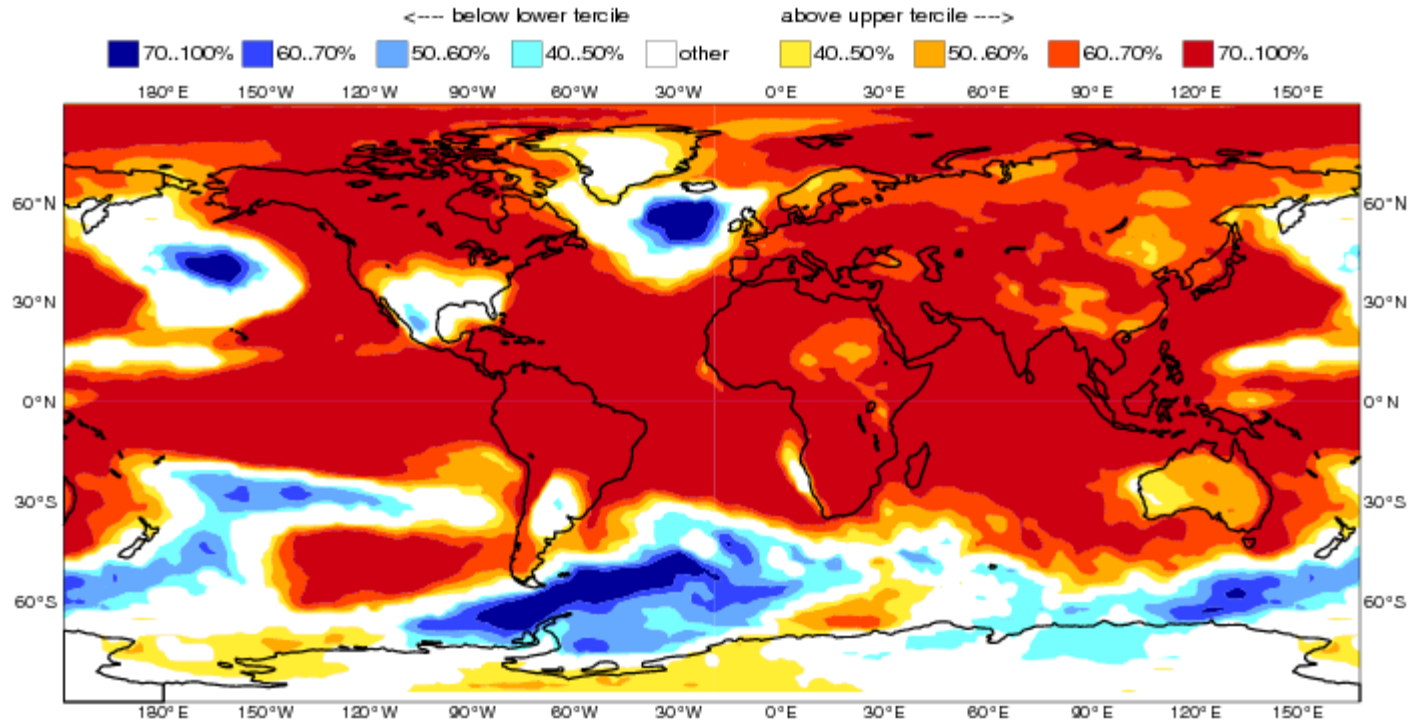

01/02/17

Climagrams : temp. area averages

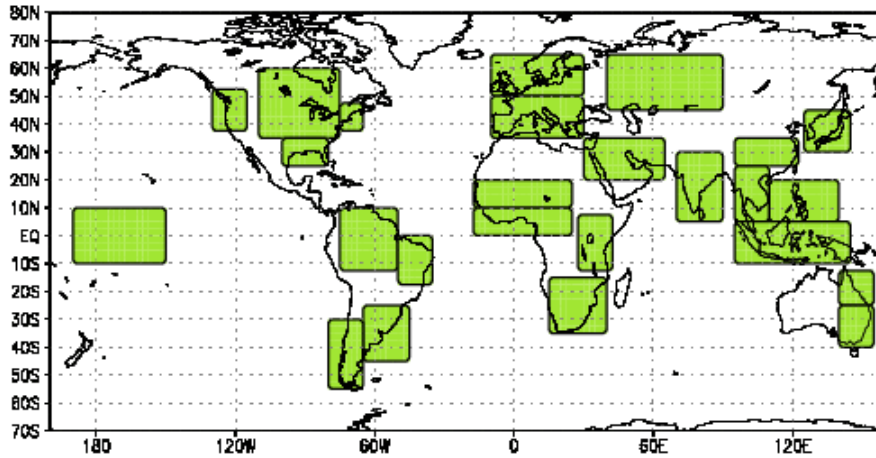

2m temp. anomalies (K) latitude= 65.0 to 50.0 longitude= -10.0 to 30.0
 Forecast initial date: 2013 201
 Ensemble size: Forecast=51 Model climate=450 Analysis climate=30

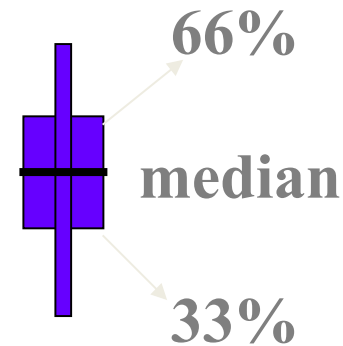
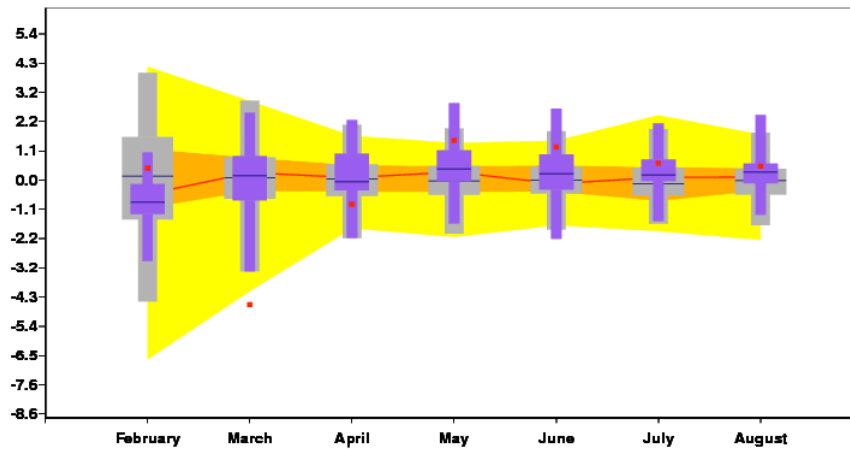

Cyclone track density new product from S4 and its verification

ECMWF Seasonal Forecast
Tropical Storm Density Anomaly
Forecast start reference is 01/05/2011
Ensemble size = 51, climate size = 300

System 4
JJASON 2011
Climate = 1990-2009

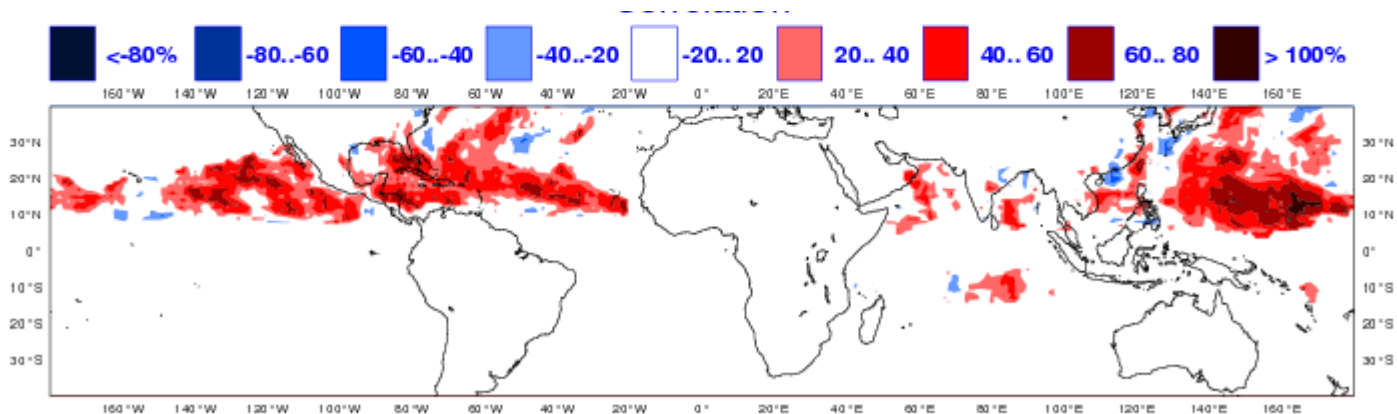
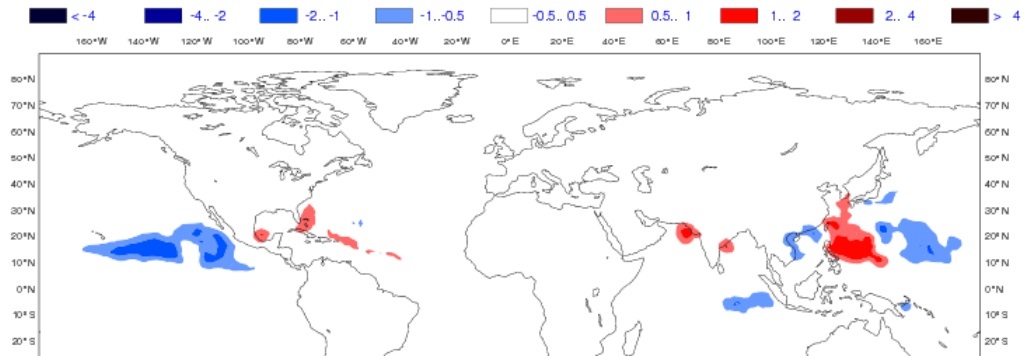

Track density for the July-Dec. period from fc. started on 1 May 1990-2010

NINO3.4 SST anomaly plume
 ECMWF forecast from 1 Aug 2013

Monthly mean anomalies relative to NCEP OIv2 1981-2010 climatology

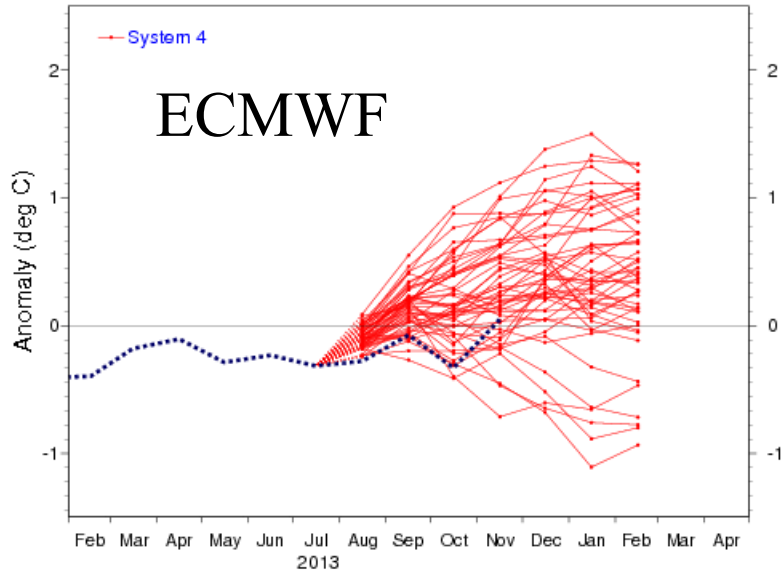

NINO3.4 SST anomaly plume
 EUROSIP multi-model forecast from 1 Aug 2013

ECMWF, Met Office, Météo-France, NCEP
 Monthly mean anomalies relative to NCEP OIv2 1981-2010 climatology

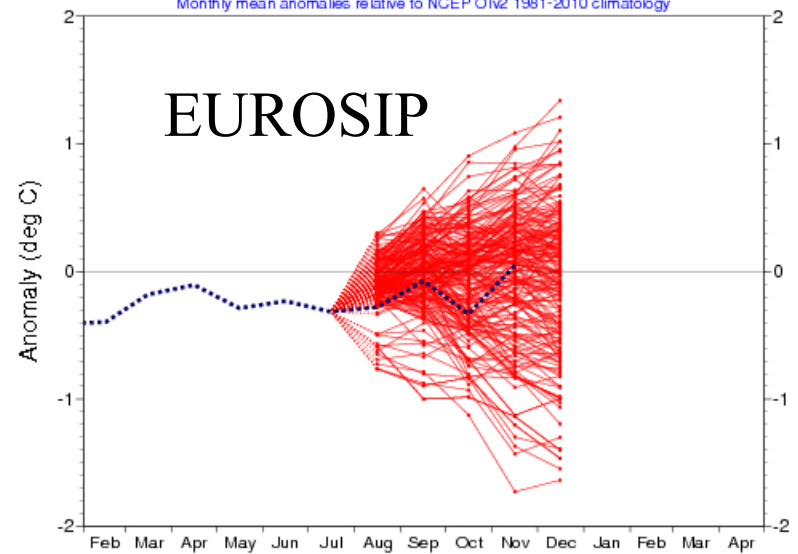

NINO3.4 SST calibrated pdf
 EUROSIP multi-model forecast from 1 Aug 2013

ECMWF, Met Office, Météo-France, NCEP
 Percentiles at 2%, 10%, 25%, 50%, 75%, 90% and 98%

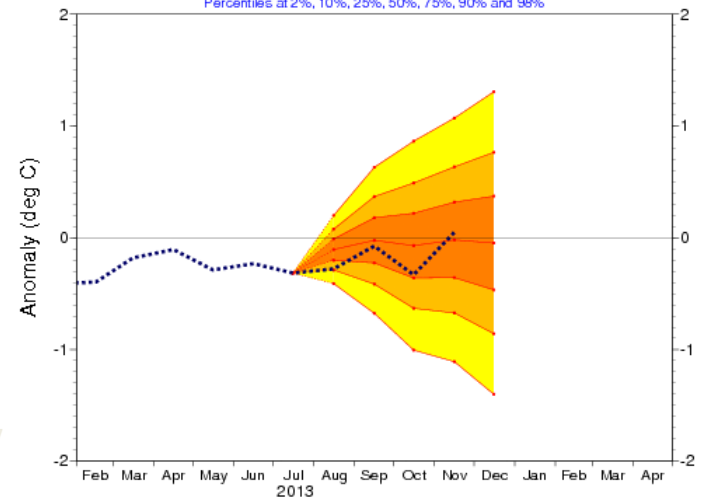

2m temperature anomalies SON

2013

ECMWF

y

System 4
SON 2013

Shaded areas significant at 10% level
Solid contour at 1% level

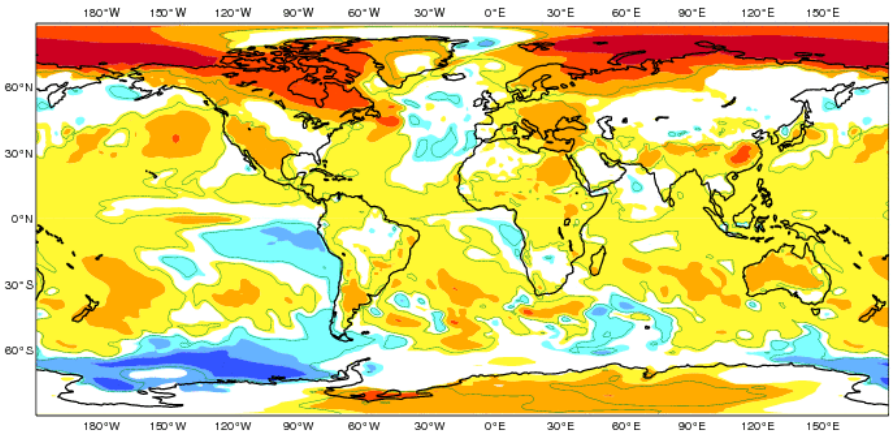
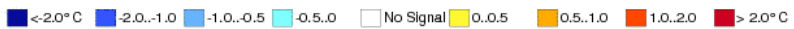

ANALYSIS

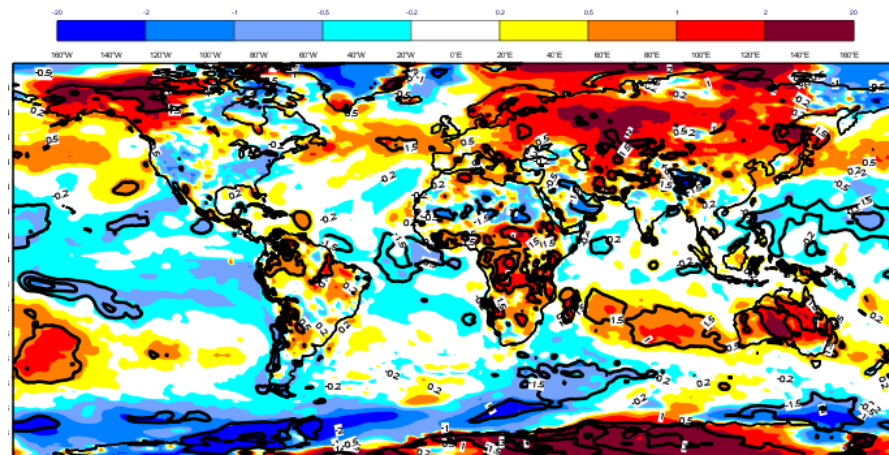

EUROSIP

ECMWF/Met Office/Meteo-France/NCEP
SON 2013

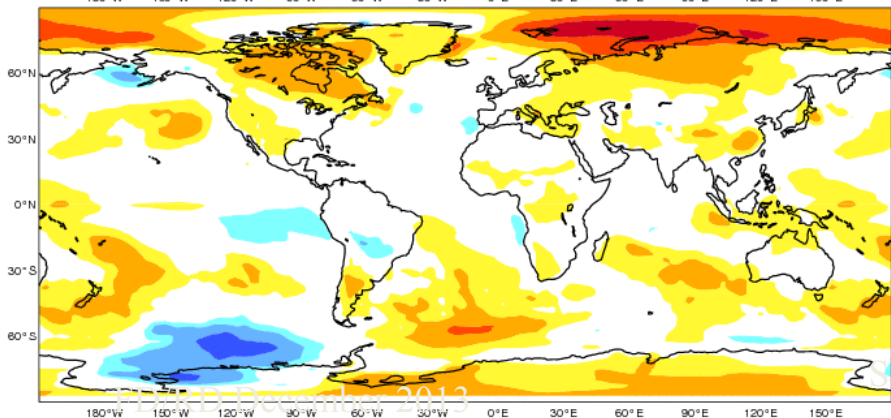
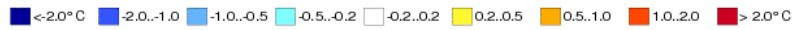

ECMWF skill

with 15 ensemble members

ensemble period: 1951-2010 with start in August. Average over months 2 to 4

Black dots for values significantly different from zero with 95% confidence (1000 samples)

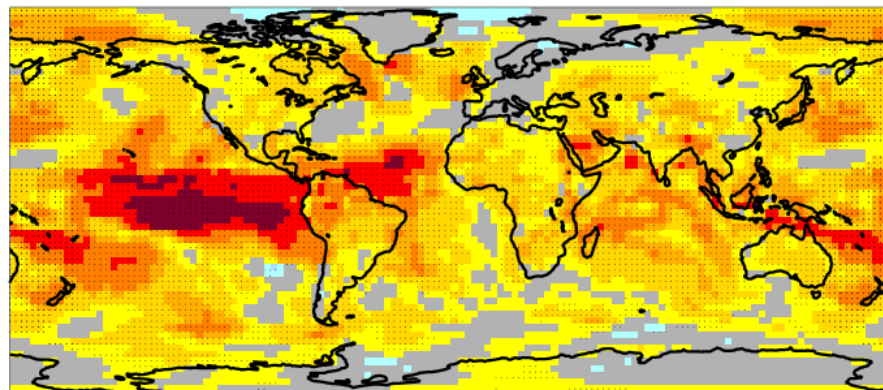
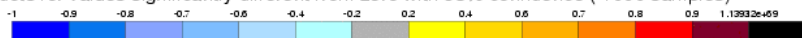

EUROSIP multi-model seasonal forecast
 Mean MSLP anomaly
 Forecast start reference is 01/11/13
 Variance-standardized mean

ECMWF/Met Office/Meteo-France/NCEP
 DJF 2013/14

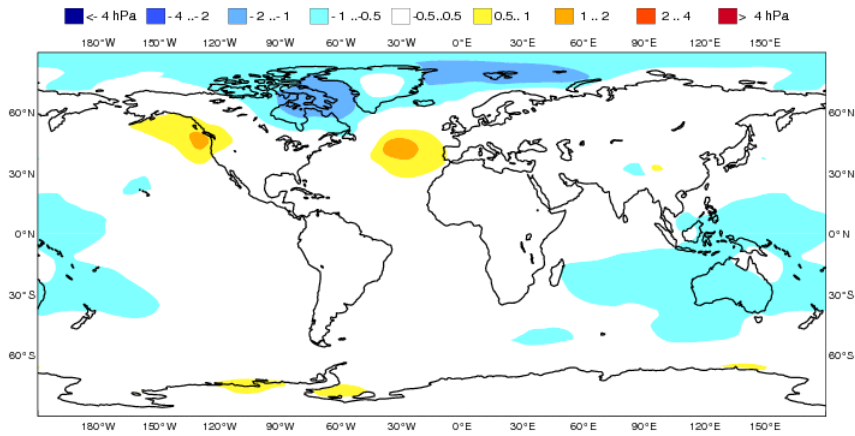

ECMWF Seasonal Forecast
 Mean MSLP anomaly
 Forecast start reference is 01/11/13
 Ensemble size = 51, climate size = 450

System 4
 DJF 2013/14
 Solid contour at 1% significance level

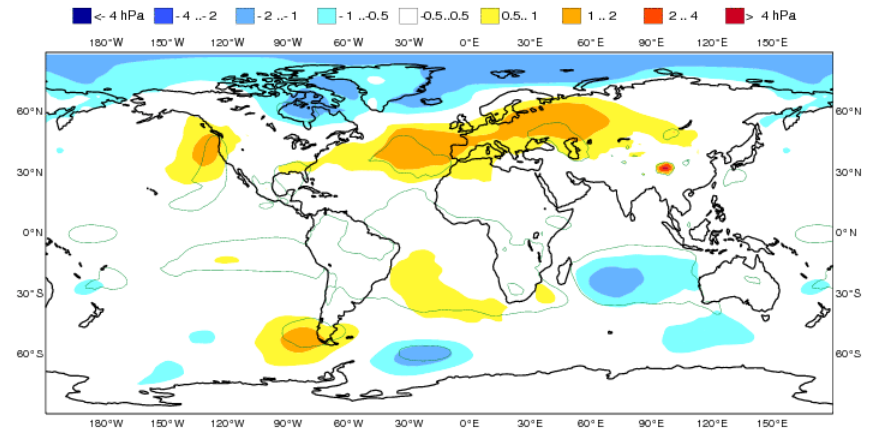

EUROSIP: Met Office contribution
 Mean MSLP anomaly
 Forecast start reference is 01/11/13
 Ensemble size = 40, climate size = 168

System 9
 DJF 2013/14
 Solid contour at 1% significance level

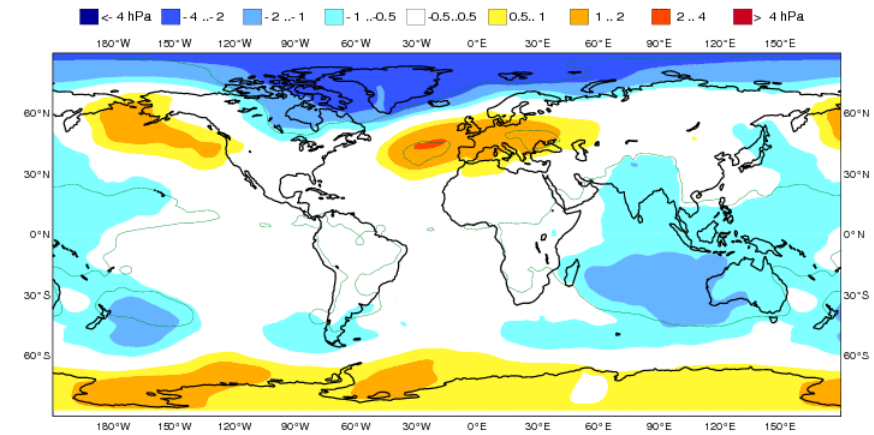

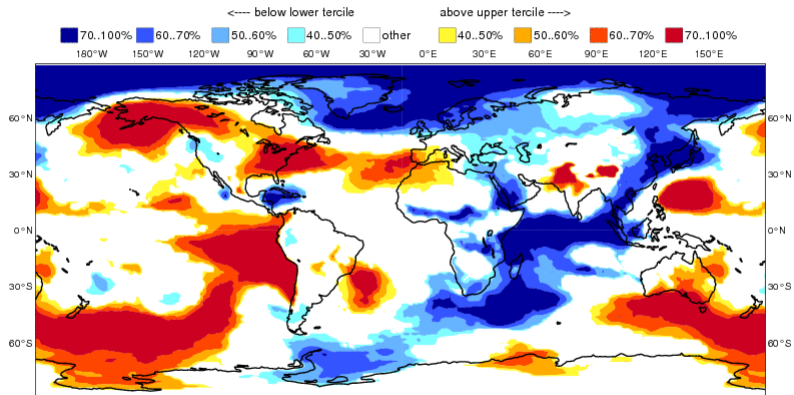

Prob(most likely category of MSLP)
Forecast start reference is 01/11/13
Ensemble size = 51, climate size = 450

DEC 2013

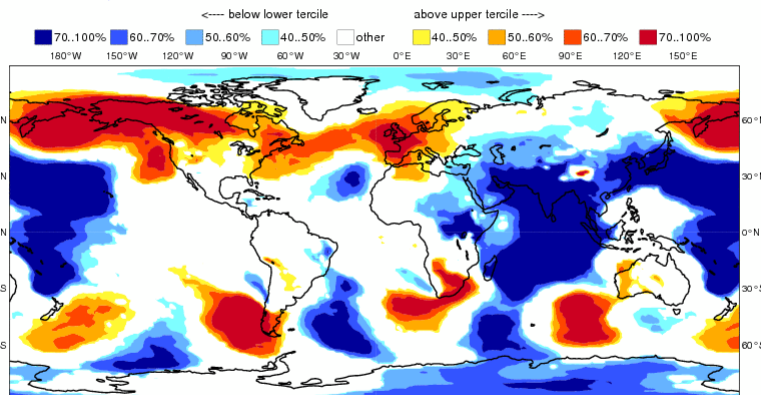

Prob(most likely category of MSLP)
Forecast start reference is 01/12/13
Ensemble size = 51, climate size = 450

JAN 2014

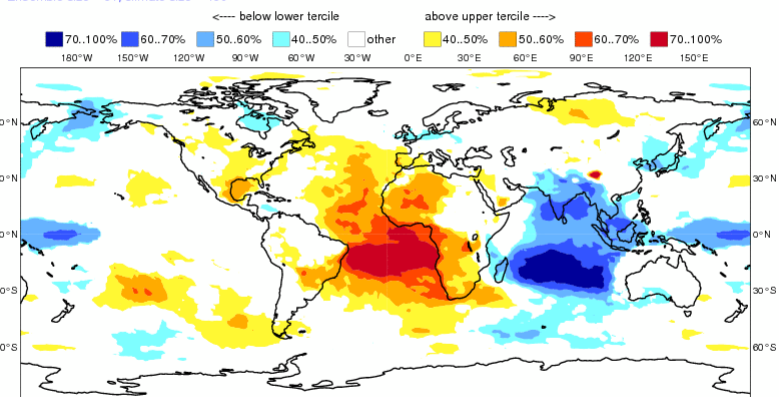

Prob(most likely category of MSLP)
Forecast start reference is 01/11/13
Ensemble size = 51, climate size = 450

JAN 2014

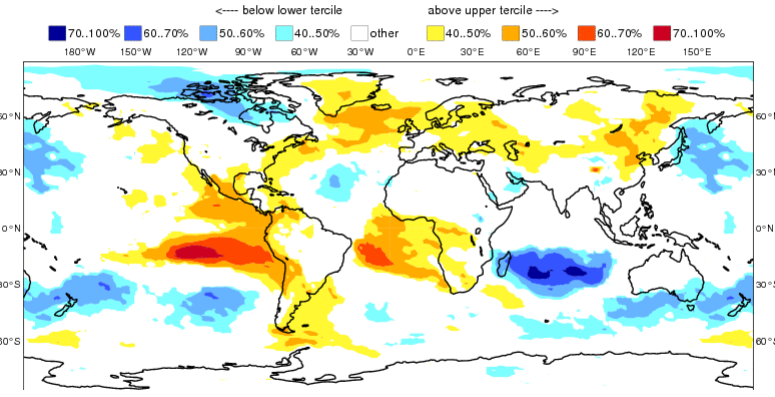

Prob(most likely category of MSLP)
Forecast start reference is 01/12/13
Ensemble size = 51, climate size = 450

FEB 2014

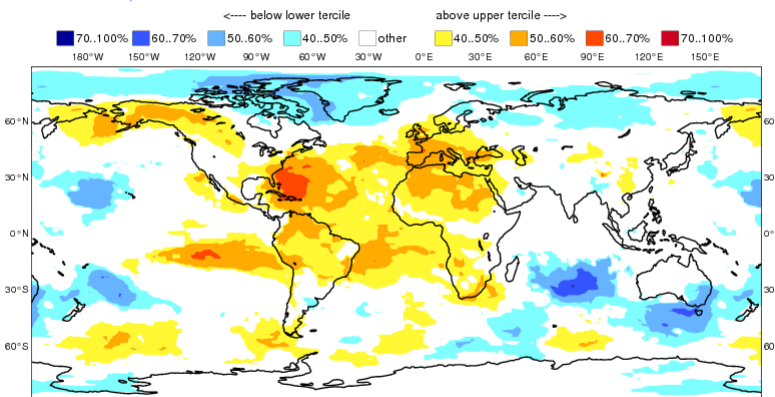
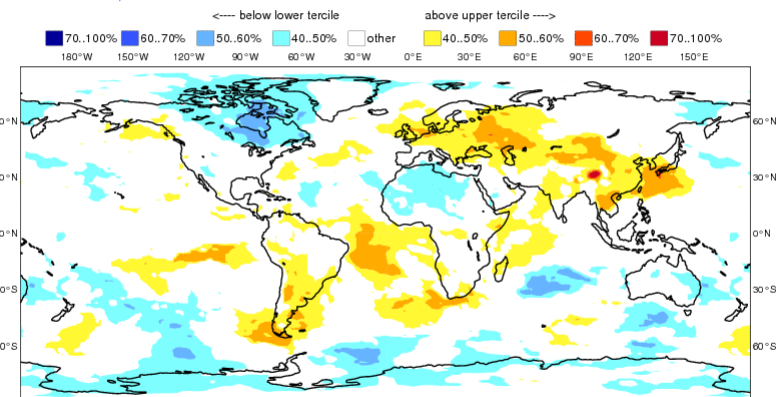

ECMWF Seasonal Forecast
Prob(most likely category of MSLP)
Forecast start reference is 01/11/13
Ensemble size = 51, climate size = 450

System 4
NOV 2013

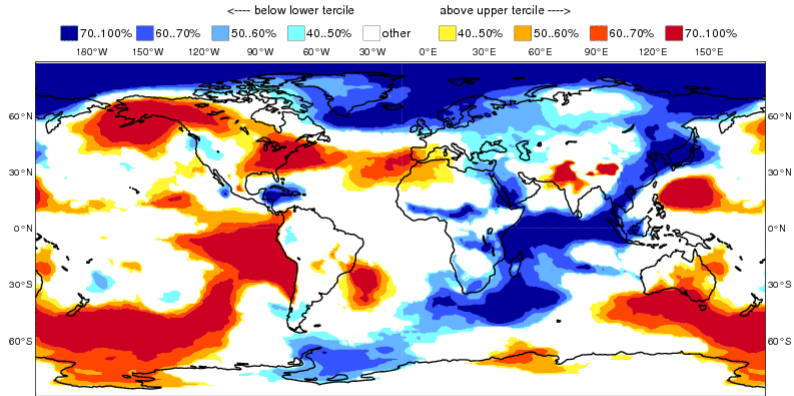

Prob(most likely category of MSLP)
Forecast start reference is 01/11/13
Ensemble size = 51, climate size = 450

DEC 2013

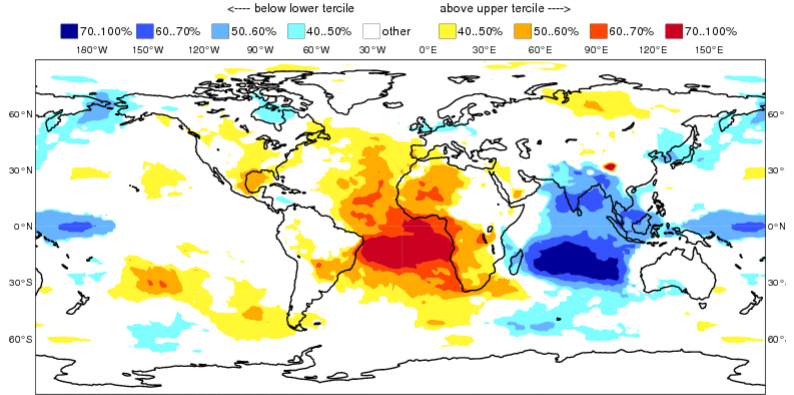

ECMWF Seasonal Forecast
Prob(most likely category of MSLP)
Forecast start reference is 01/12/13
Ensemble size = 51, climate size = 450

System 4
DEC 2013

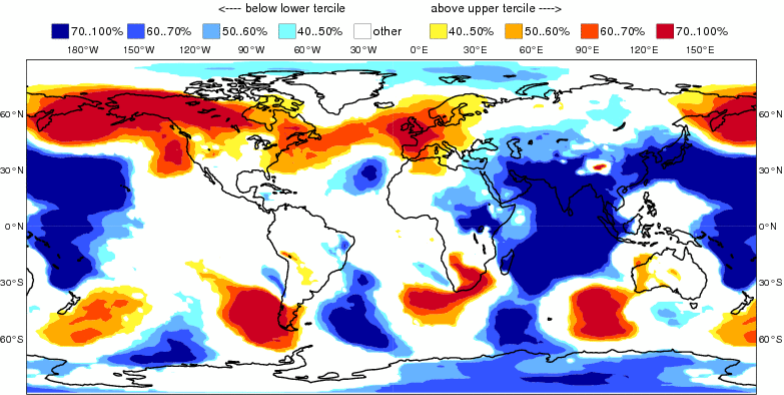

3.4 outlook

NINO3.4 SST anomaly plume
EUROSIP multi-model forecast from 1 Jan 2013
ECMWF, Met Office, Météo-France, NCEP

Monthly mean anomalies relative to NCEP OIv2 1981-2010 climatology

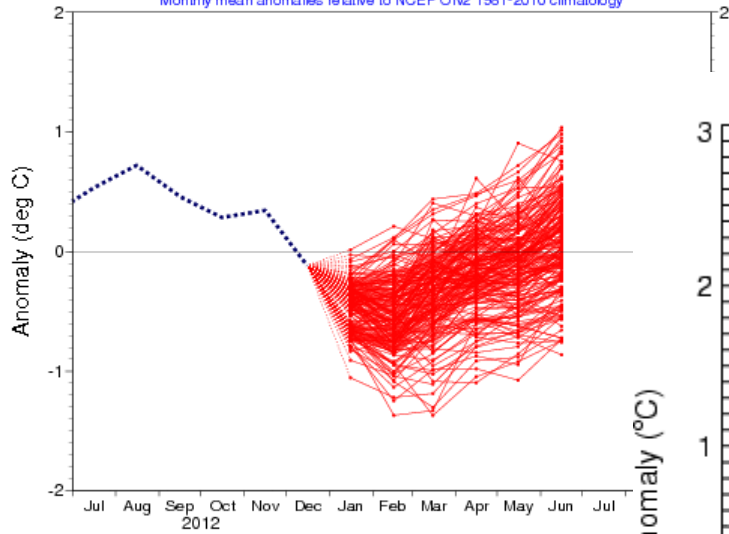

ENSO Predictions from Feb 2011 to Nov 2012

IRI

◇ Dynamical models
○ Statistical models
● ECMWF

Nino3.4 SST Anomaly (°C)

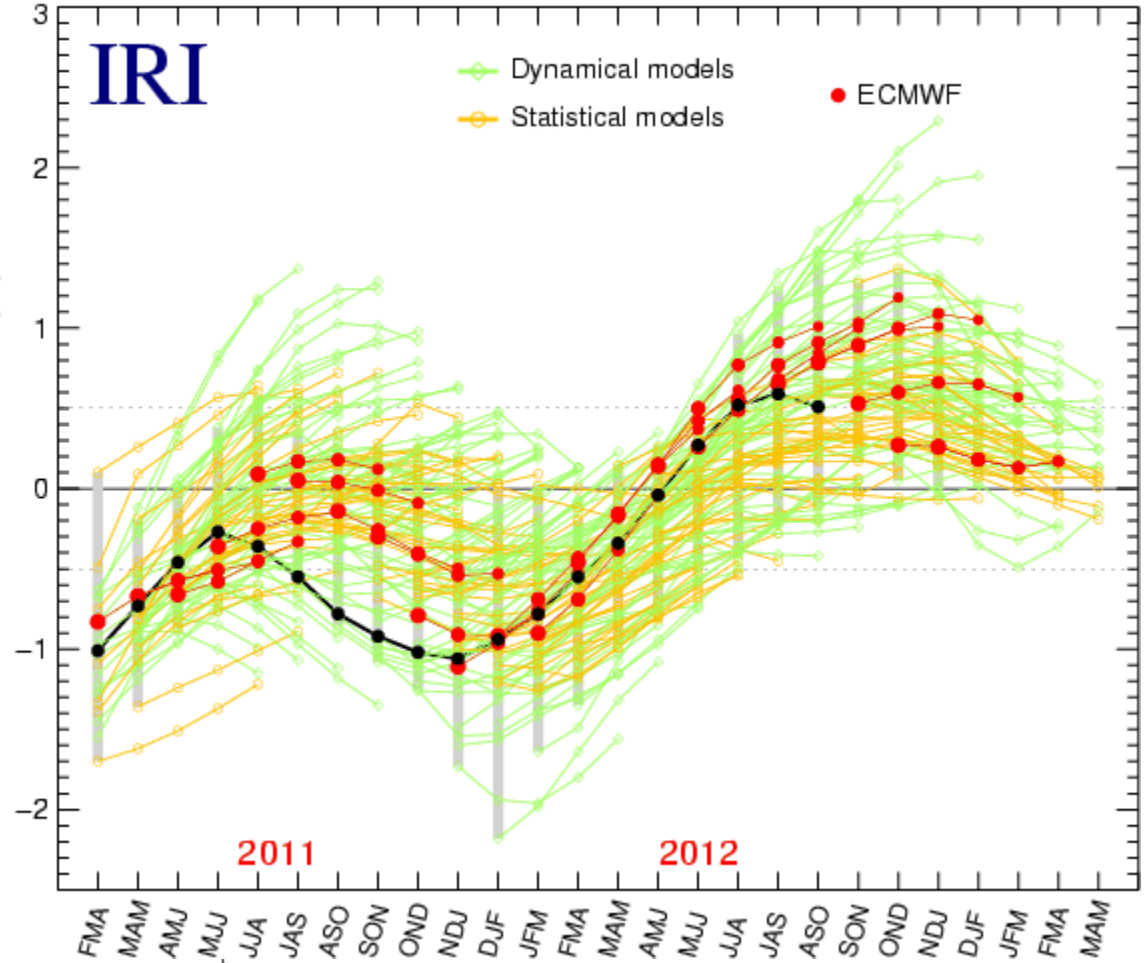

2011

2012

NINO 3.4 past predictions

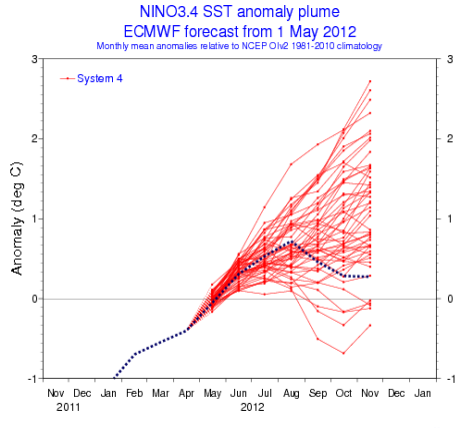

CECWF

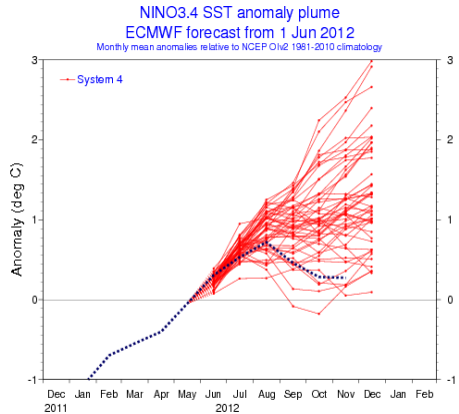

CECWF

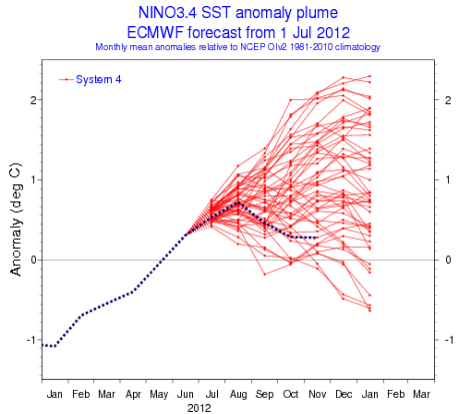

CECWF

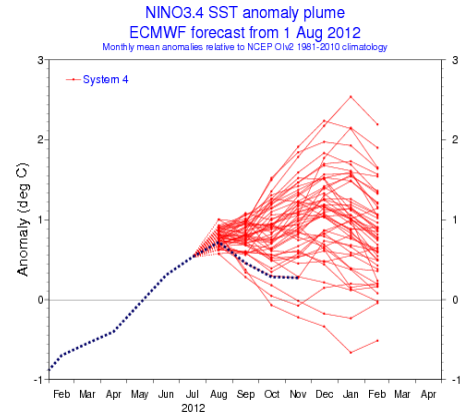

CECWF

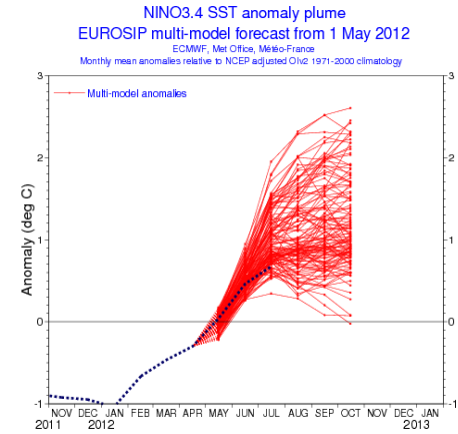

CECWF

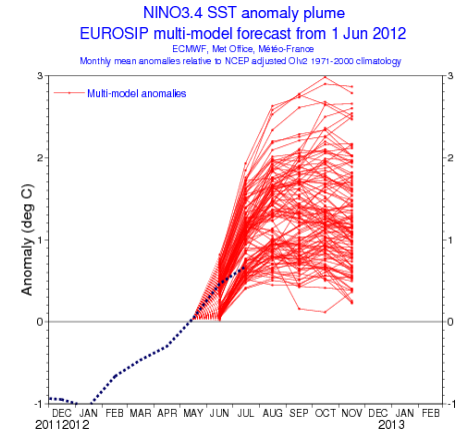

CECWF

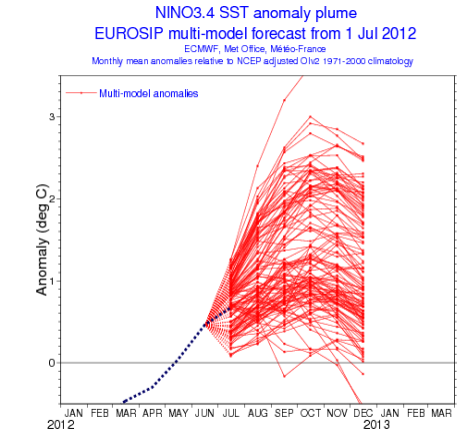

CECWF

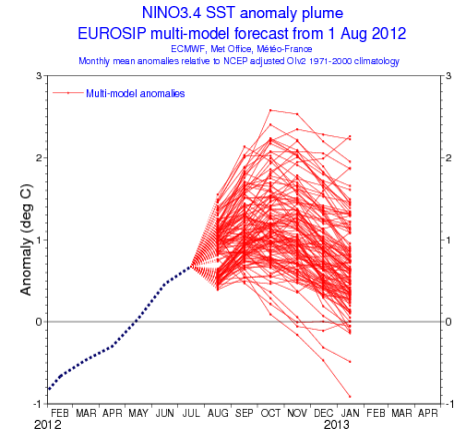

CECWF

Forecast issue date: 15 May 2012

Forecast issue date: 15 Jun 2012

Forecast issue date: 15 Jul 2012

Forecast issue date: 15 Aug 2012

Extended range predictions

- Products from Extended range predictions are generally defined with reference to the model climate estimated by the re-forecast data.
- Post-processing/calibration of model data is in units of standard deviations.
- For each member of the ensemble we define the anomaly as $An(t) = For.(t) - Model\ Climate(t)$

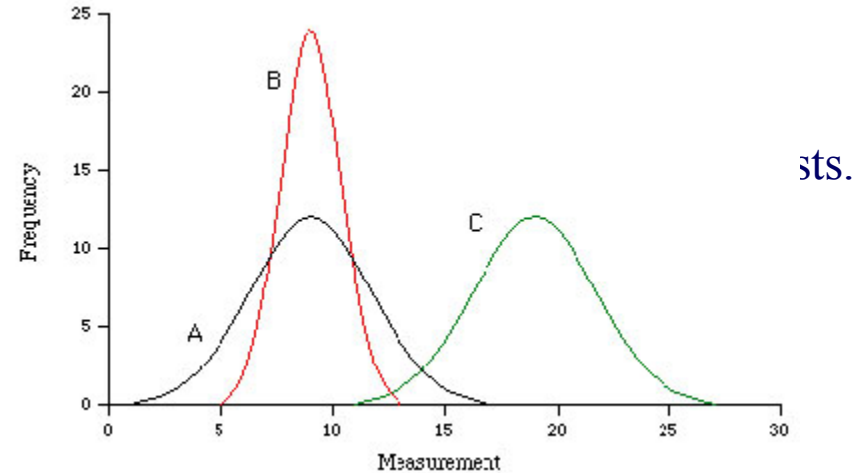

Model climate distribution

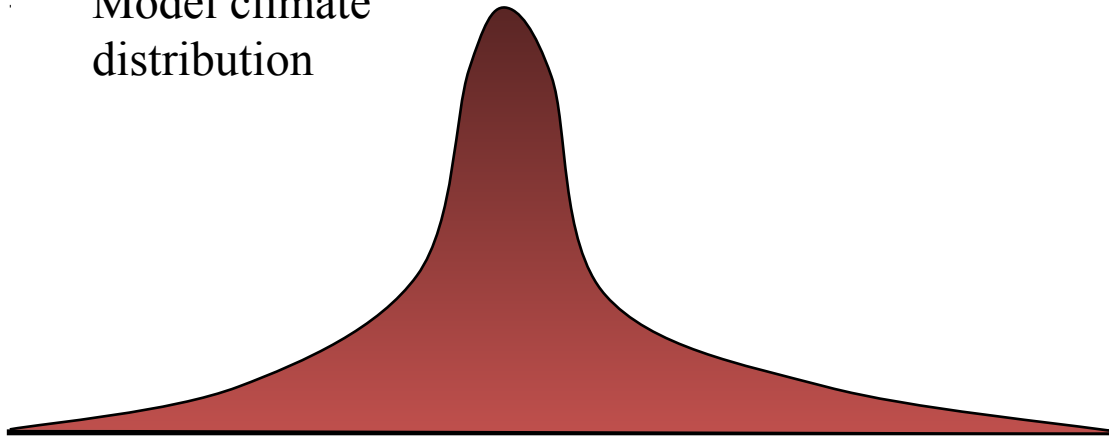

Re-forecast	Seasonal
Period	30 years
Ens. Size	15
Frequency	monthly

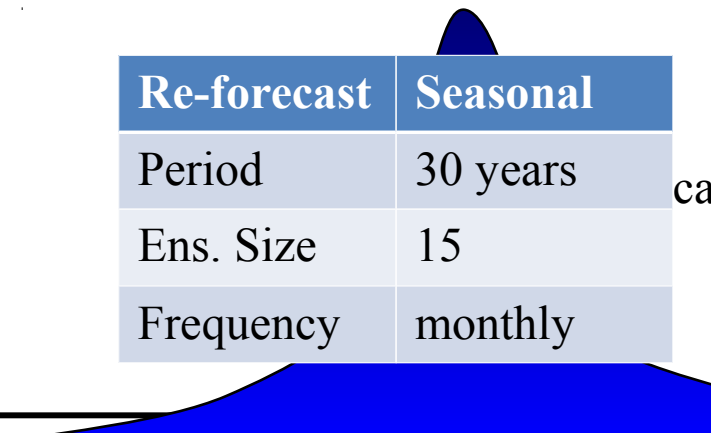

Ocean analysis:

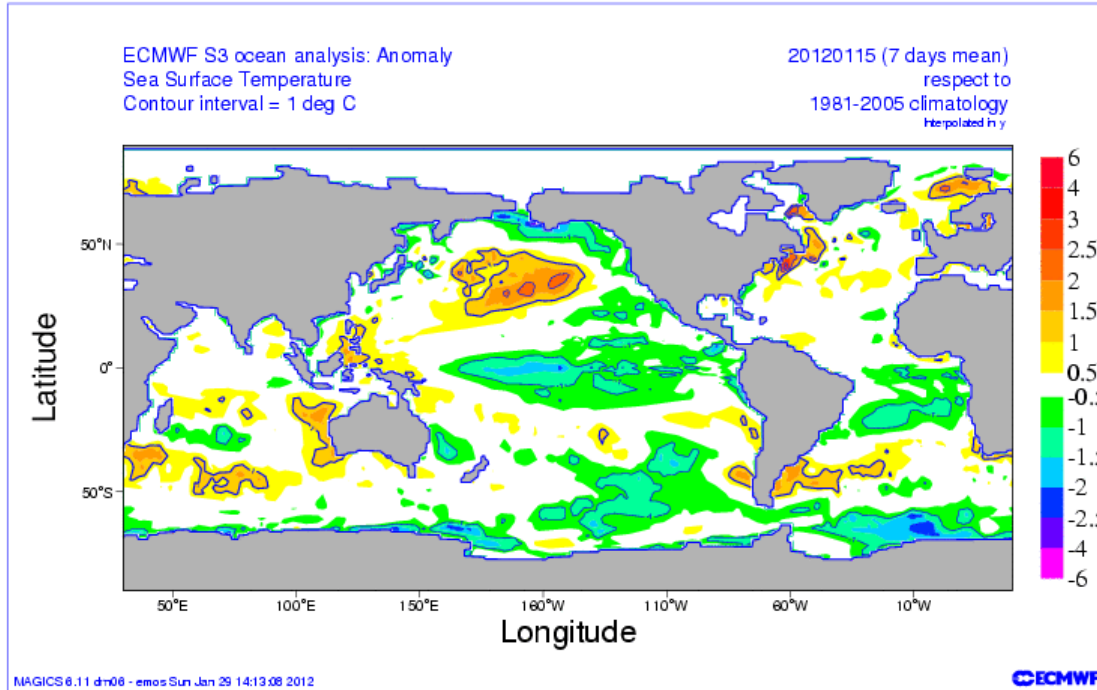

Daily weekly and monthly products are available on the web

01/02/17

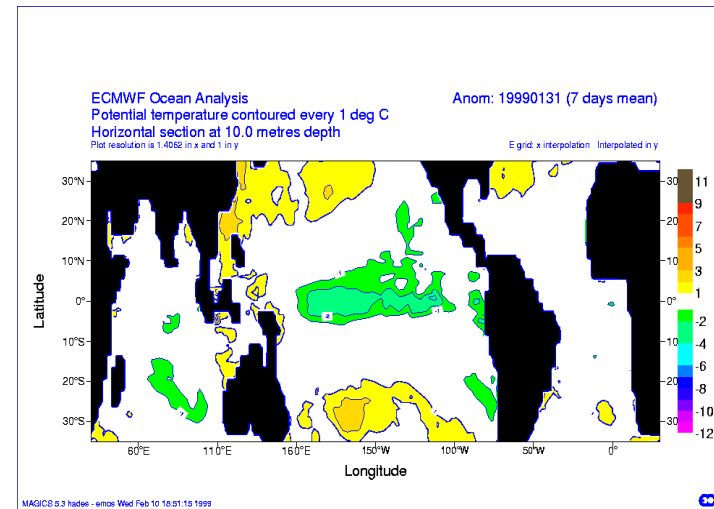
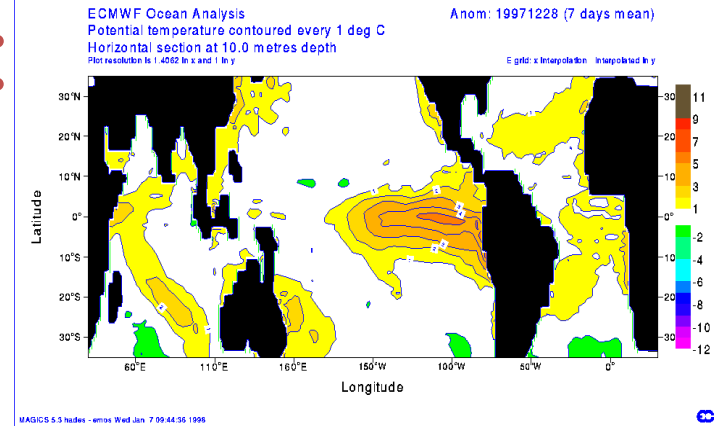

Ocean analysis:

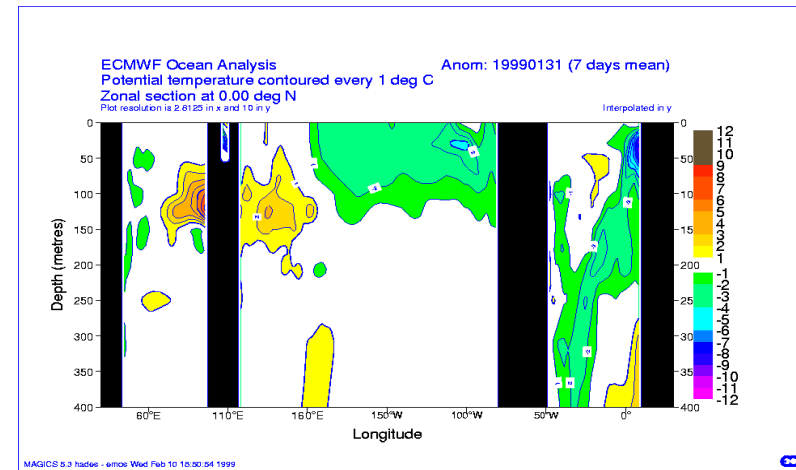
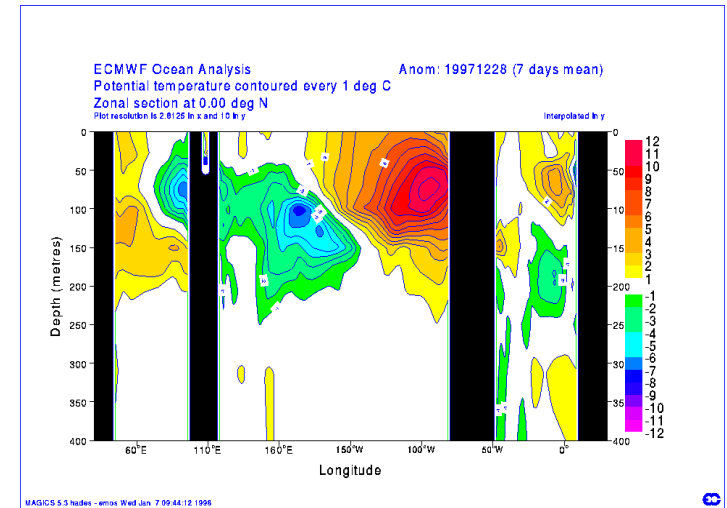
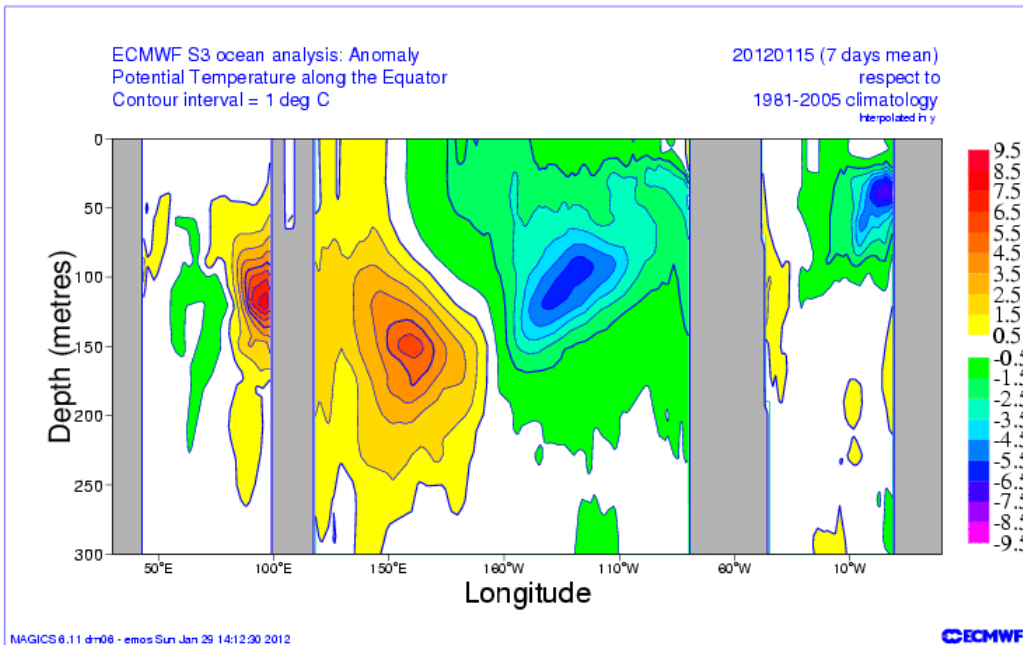

Chaotic nature of the atmosphere:

- To deal with the chaotic processes in the atmosphere we use an ensemble of simulations: on the 1st of the month 40 forecasts are run for 6 months. They have initial conditions from 5-member ensemble of ocean analyses (wind perturbations throughout analysis and SST perturbations at start of forecasts)
- Seasonal forecasting does not give exact predictions, but it may allow us to describe the probability that a certain weather event can happen.

Calibration of ENSO SST indices

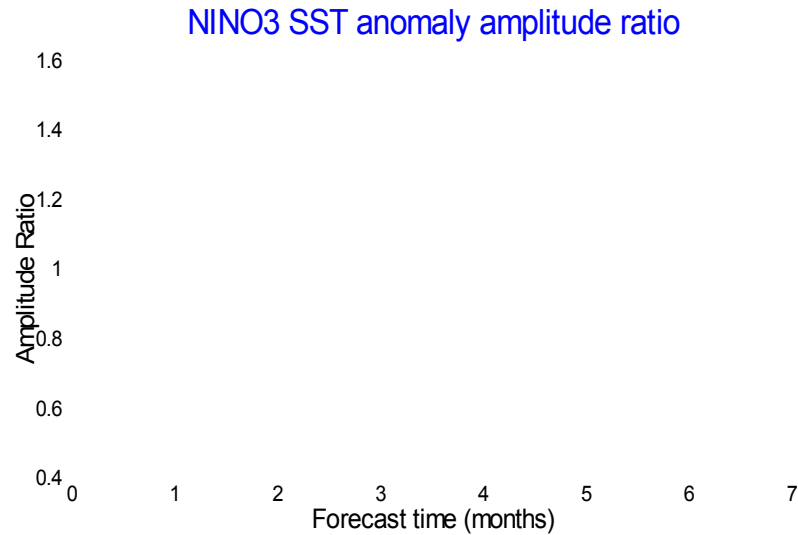

S4 non calib.
S4 calibrated
S3

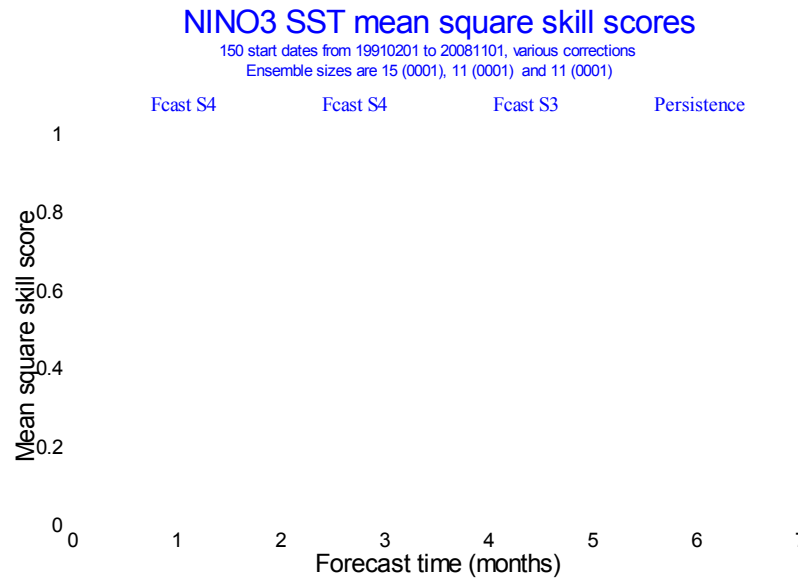

SST scores: Nino 3.4 and Eq.

Atlantic

NINO3.4 SST rms errors

360 start dates from 19810101 to 20101201, various corrections
 Ensemble sizes/corrections are 15/AS (0001) and 11/BC (0001)
 95% confidence interval for 0001, for given set of start dates

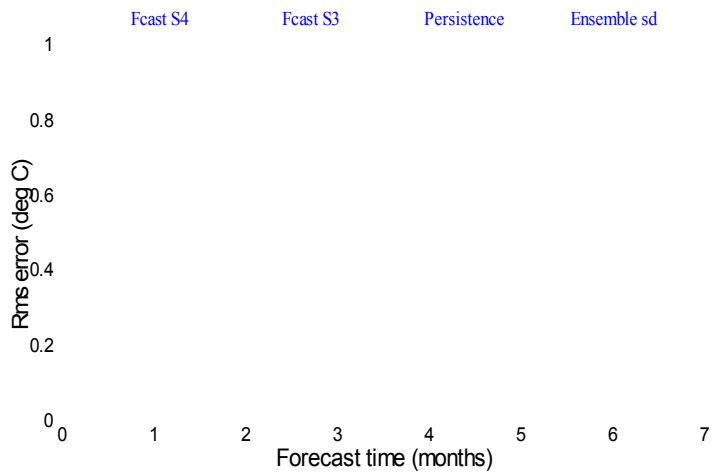

EQATL SST rms errors

360 start dates from 19810101 to 20101201, various corrections
 Ensemble sizes/corrections are 15/AS (0001) and 11/BC (0001)
 95% confidence interval for 0001, for given set of start dates

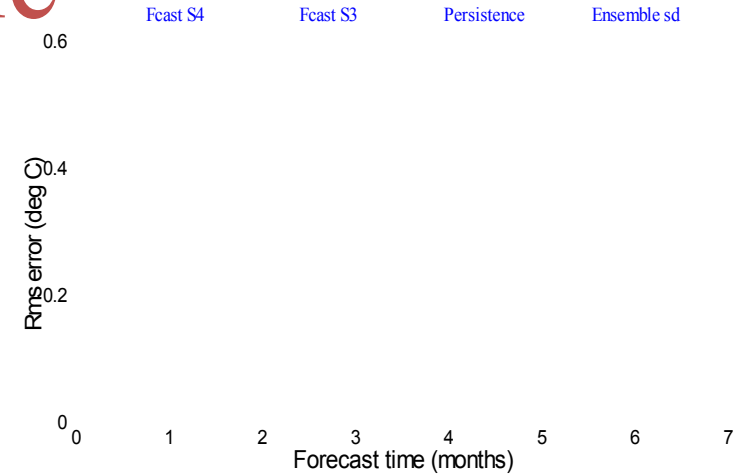

Solid:
 S4 error
 S3 error
 Dashed:
 S4
 spread
 S3

NINO3.4 SST anomaly correlation

wrt NCEP adjusted OI2 1971-2000 climatology

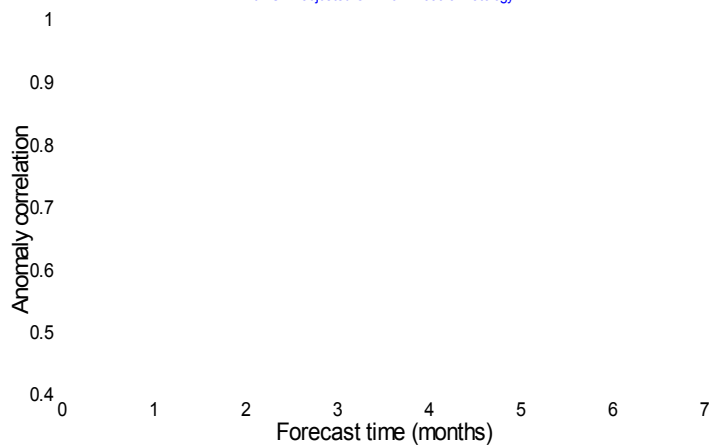

EQATL SST anomaly correlation

wrt NCEP adjusted OI2 1971-2000 climatology

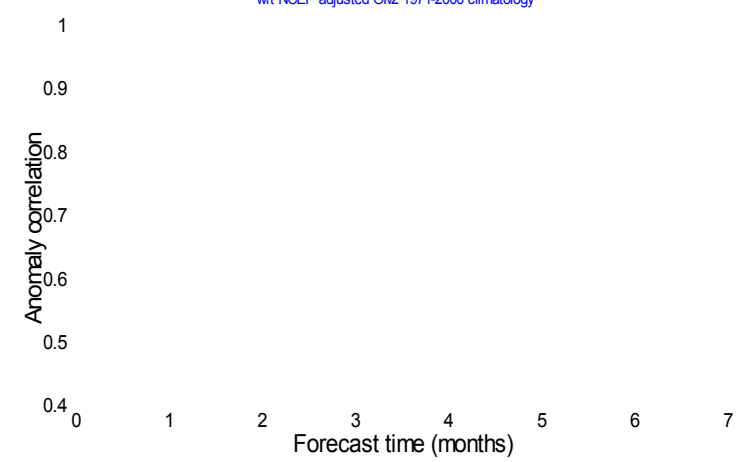

spread
 S4 ACC
 S3 ACC
 Pers.
 ACC

EUROsip seasonal forecasts of tropical storms

Forecasts starting on 1st June

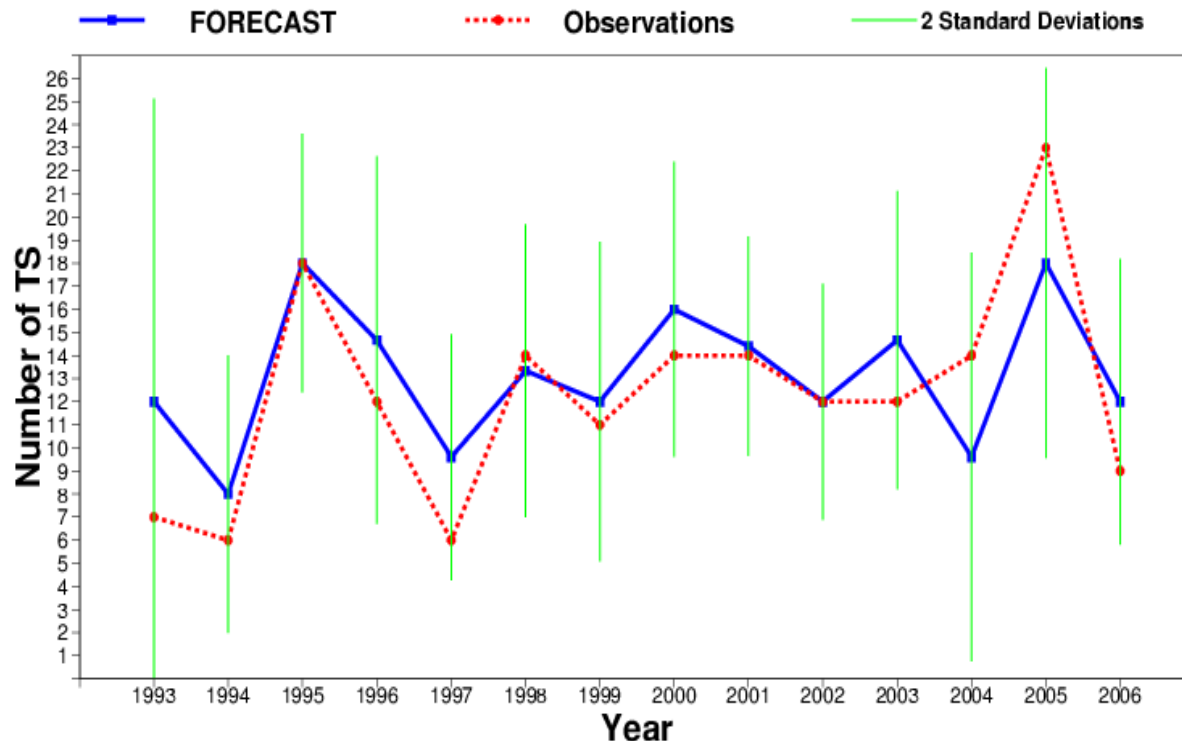

Bias in S4 re-forecasts: SST (DJF)

Start: 1 Nov.

1981/2010

Verify: Dec-Feb

System 4

Sea Surface temperature
Hindcast period 1981-2010 with start in November average over months 2 to 4

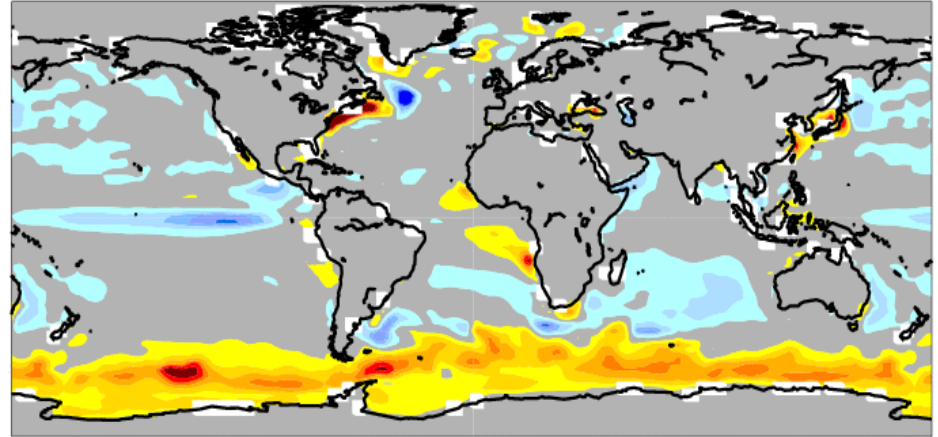

System 3

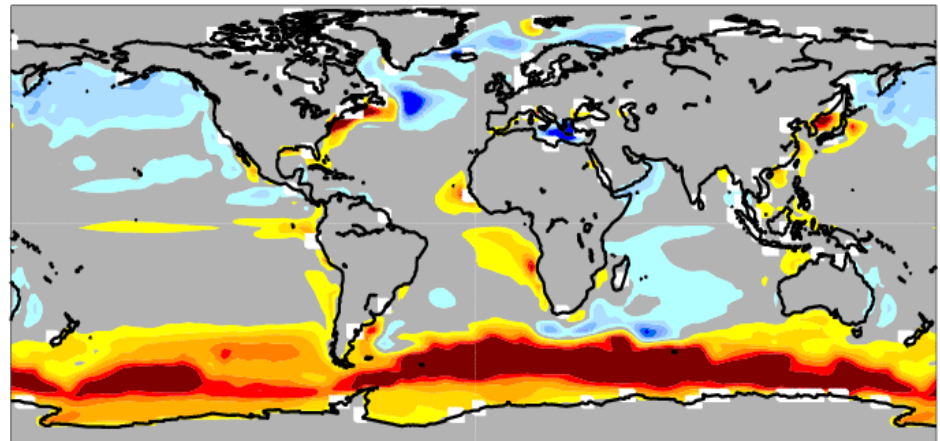

Bias in S4 re-forecasts: rainfall (JJA)

Start: 1 May

1981/2010

Verify: Jun-Aug

System 4

Precipitation

Hindcast period 1981-2008 with start in May average over months 2 to 4

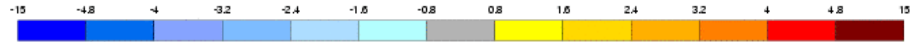
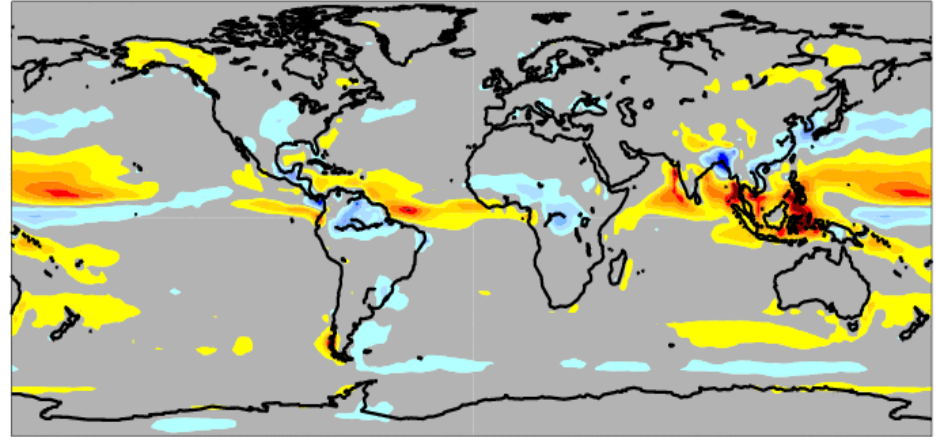

System 3

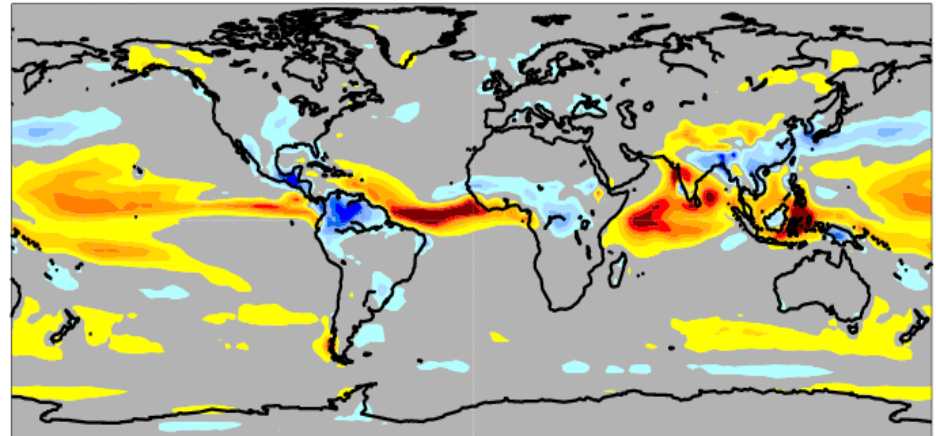

Ens-mean ACC in S4 re-forecasts: 2m T (JJA)

Start: 1 May

1981/2010

Verify: Jun-Aug

System 4

Near-surface air temperature

Hindcast period 1981-2010 with start in May average over months 2 to 4

Black dots for values significantly different from zero with 95% confidence (1000 samples)

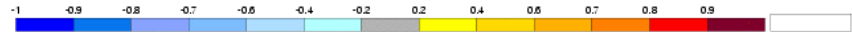
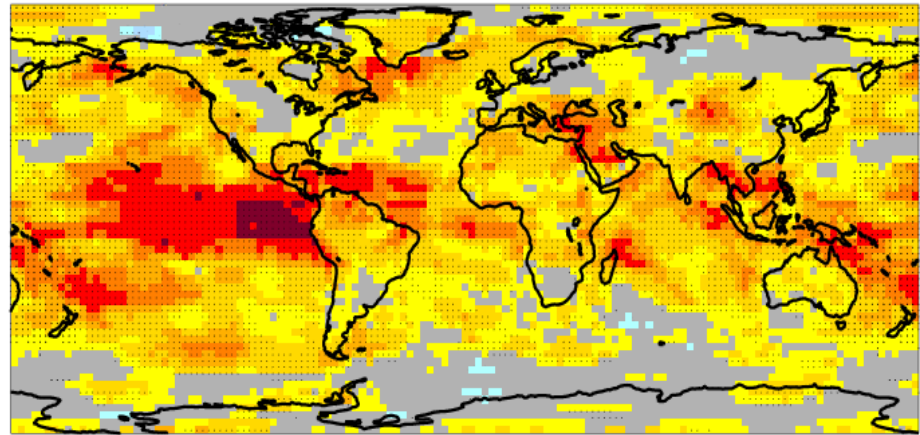
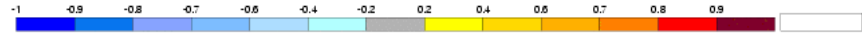

System 3

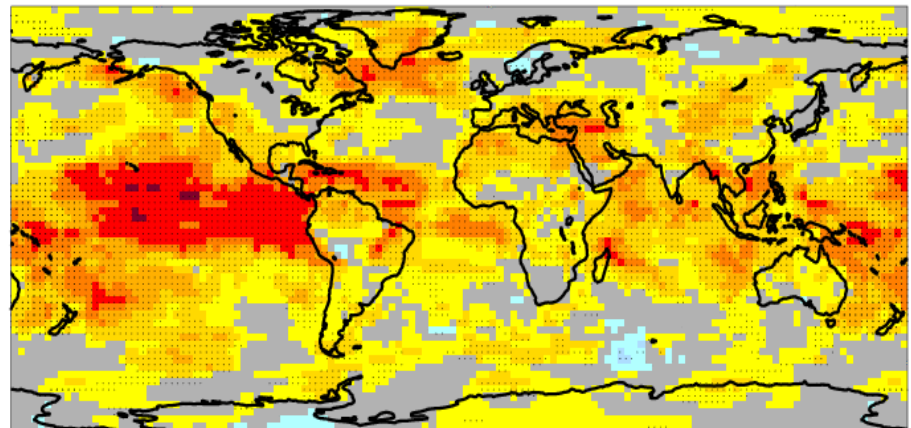

Weather-related natural disasters

Societal Impacts from 1997/98 El Niño

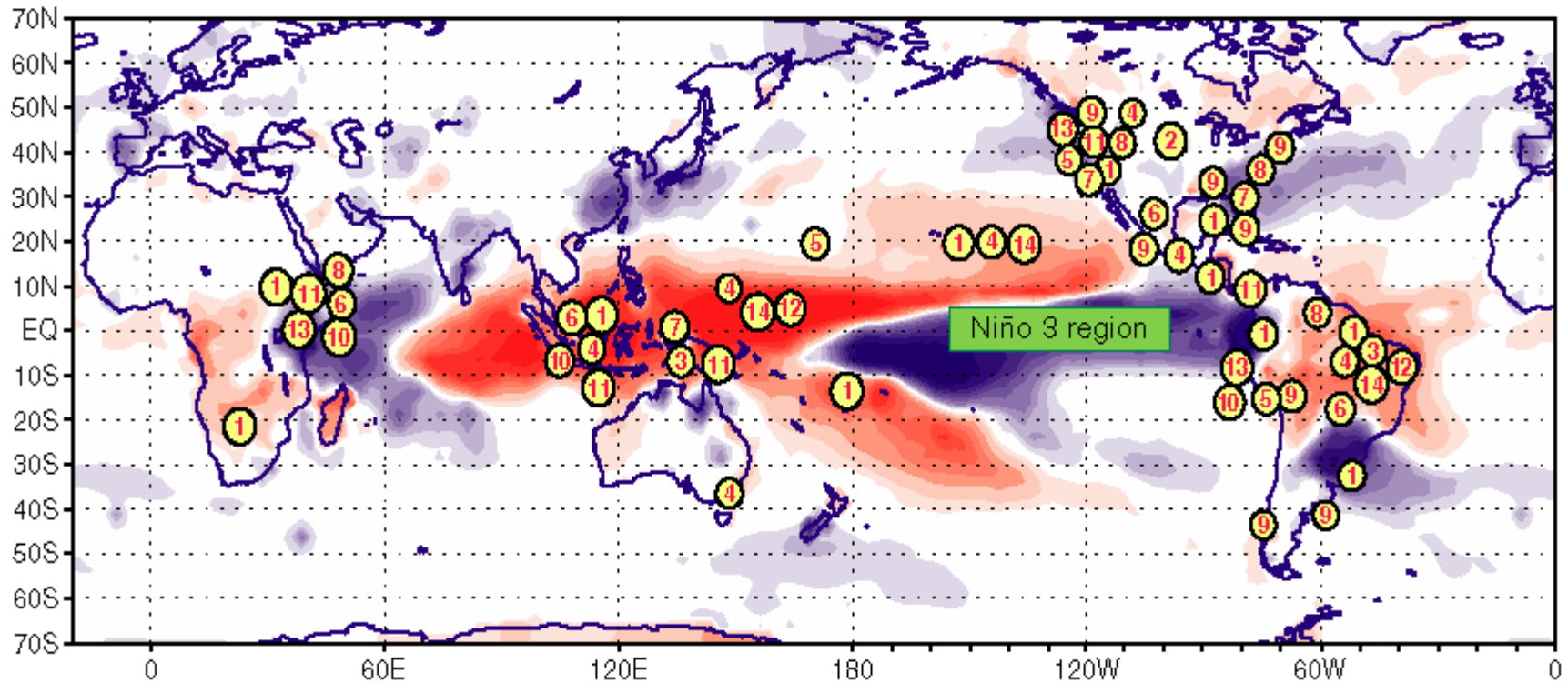

- | | | | |
|----------------------|-------------------------|-----------------------------|-------------------------|
| 1. Crop/Stock Damage | 5. Fisheries Disruption | 9. Property Damage | 13. Wildlife Fatalities |
| 2. Energy Savings | 6. Health Risks | 10. Tourism Decreased | 14. Water Rationing |
| 3. Famine | 7. Human Fatalities | 11. Transportation Problems | |
| 4. Fires | 8. Pests Increased | 12. Social Disruptions | |



Climate Prediction Center

NINO3.4 plumes

NINO3.4 SST anomaly plume
EUROSIP multi-model forecast from 1 Jan 2016
ECMWF, Met Office, Météo-France, NCEP
Monthly mean anomalies relative to NCEP Olv2 1981-2010 climatology

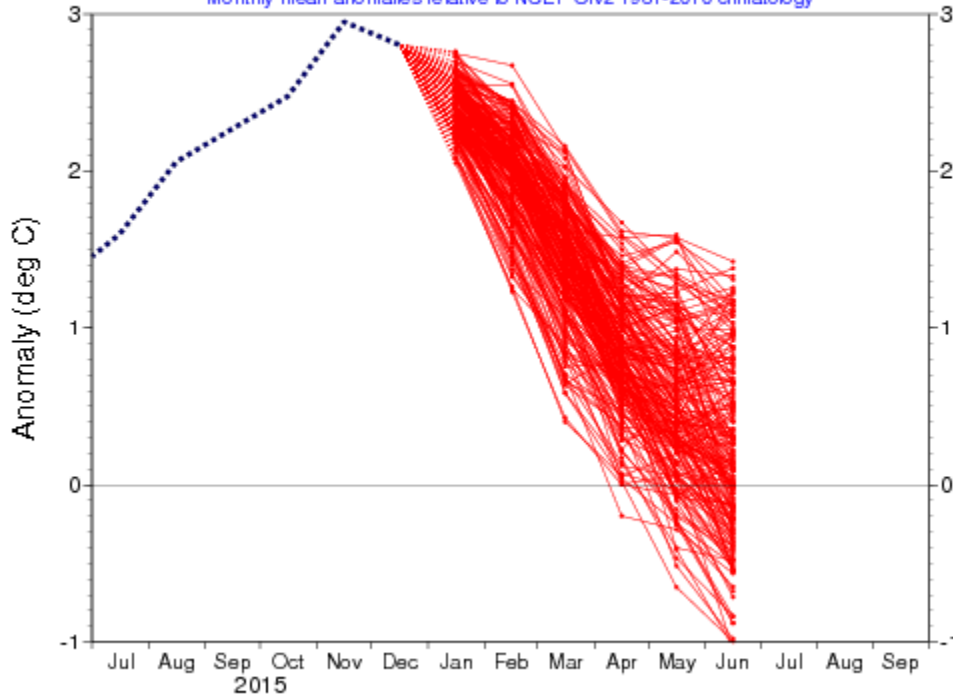

ECMWF

Nino3.4, Lon = [-170, -120], Lat = [-5, 5]
Nino12, Lon = [-90, -80], Lat = [-10, 0]
Nino4, Lon = [160, -150], Lat = [-5, 5]
Nino3, Lon = [-150, -90], Lat = [-5, 5]

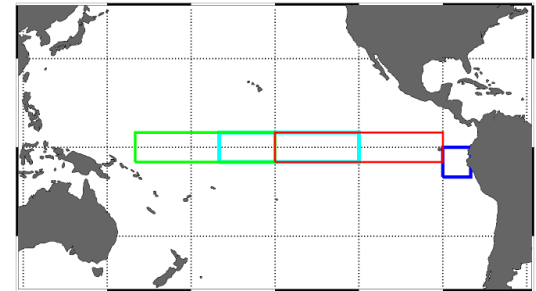

Forecast is made available on the 8h of each month

NINO3.4 SST anomaly plume
EUROSIP multi-model forecast from 1 Dec 2013
ECMWF, Met Office, Météo-France, NCEP
Monthly mean anomalies relative to NCEP OIv2 1981-2010 climatology

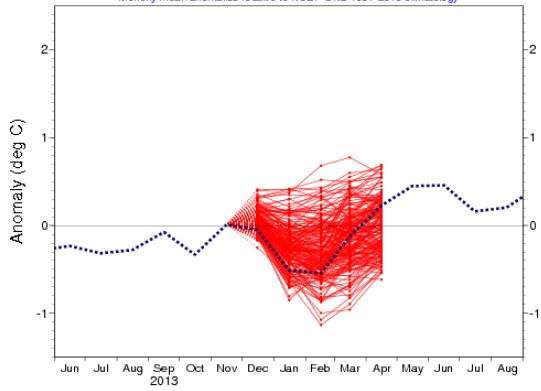

ECMWF

NINO3.4 SST anomaly plume
EUROSIP multi-model forecast from 1 Feb 2014
ECMWF, Met Office, Météo-France, NCEP
Monthly mean anomalies relative to NCEP OIv2 1981-2010 climatology

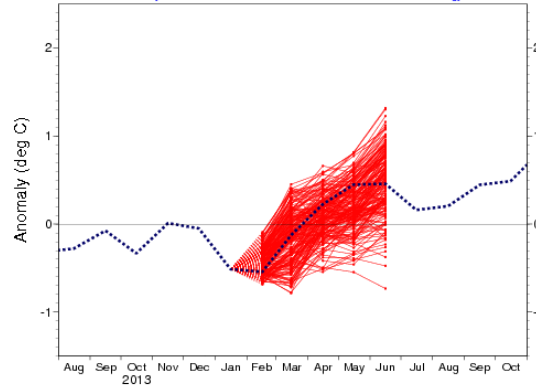

NINO3.4 SST anomaly plume
EUROSIP multi-model forecast from 1 Apr 2014
ECMWF, Met Office, Météo-France, NCEP
Monthly mean anomalies relative to NCEP OIv2 1981-2010 climatology

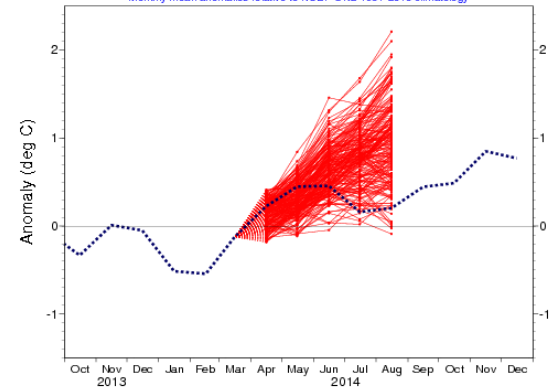

ECMWF

NINO3.4 SST anomaly plume
EUROSIP multi-model forecast from 1 Jun 2014
ECMWF, Met Office, Météo-France, NCEP
Monthly mean anomalies relative to NCEP OIv2 1981-2010 climatology

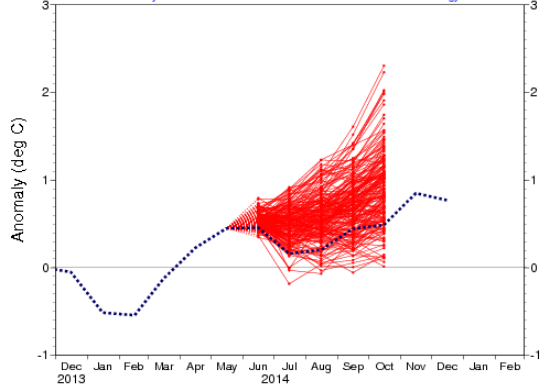

NINO3.4 SST anomaly plume
EUROSIP multi-model forecast from 1 Aug 2014
ECMWF, Met Office, Météo-France, NCEP
Monthly mean anomalies relative to NCEP OIv2 1981-2010 climatology

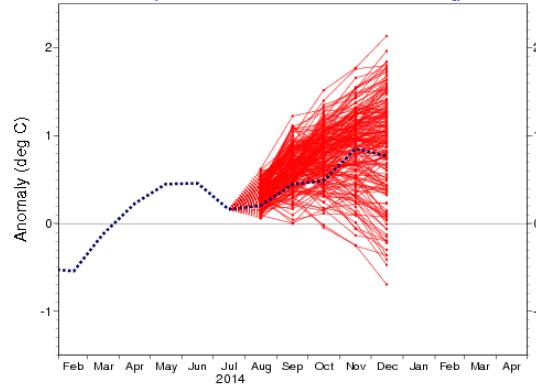

NINO3.4 SST anomaly plume
EUROSIP multi-model forecast from 1 Oct 2014
ECMWF, Met Office, Météo-France, NCEP
Monthly mean anomalies relative to NCEP OIv2 1981-2010 climatology

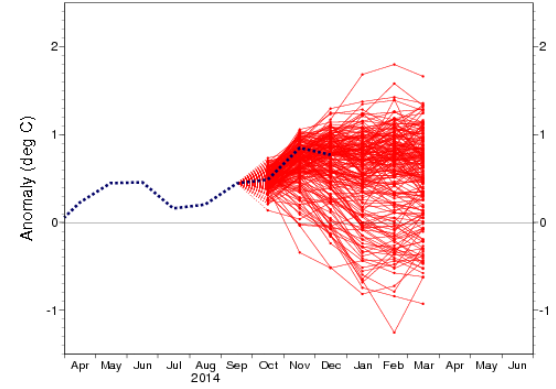

NINO3.4 SST anomaly plume
EUROSIP multi-model forecast from 1 Dec 2014
ECMWF, Met Office, Météo-France, NCEP
Monthly mean anomalies relative to NCEP OIv2 1981-2010 climatology

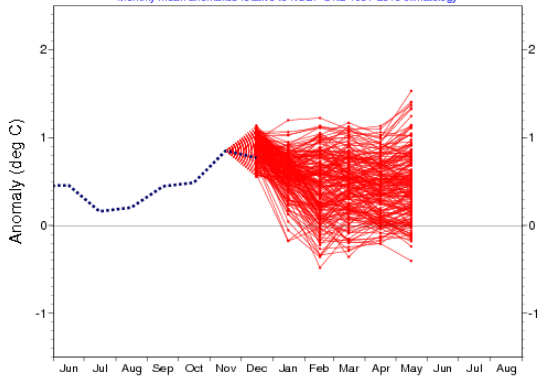

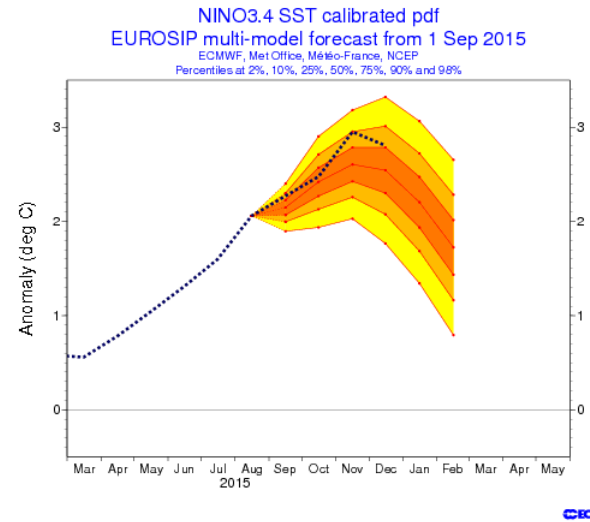
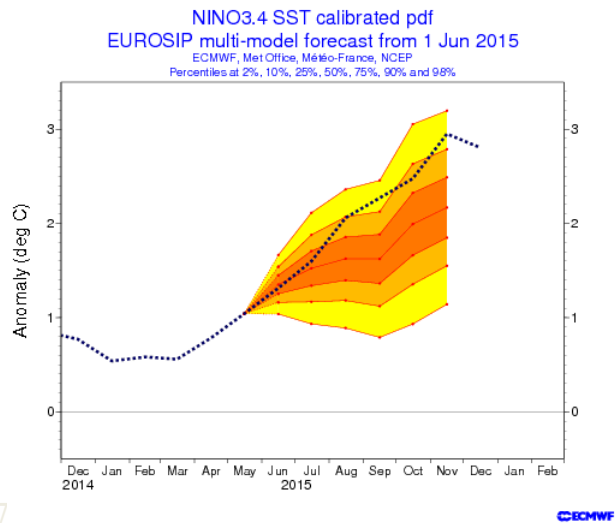
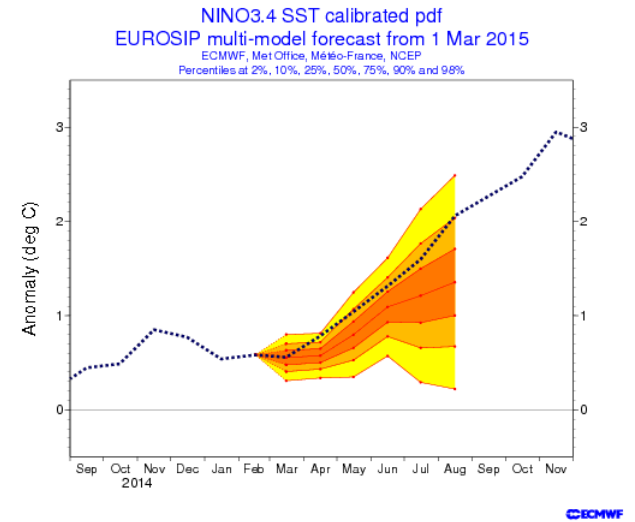
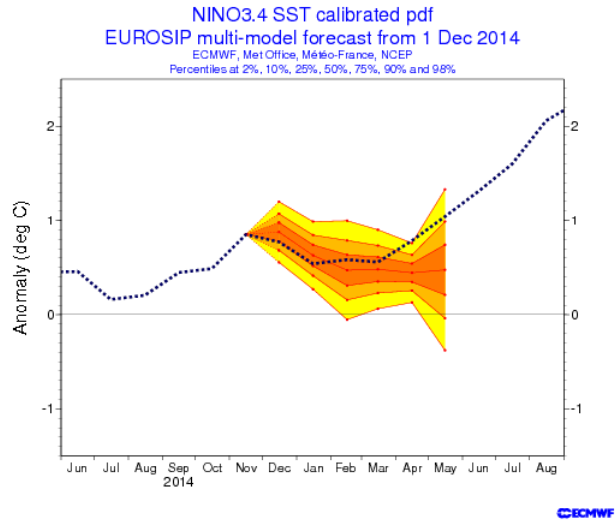

Extended range predictions

Products from Extended range predictions are generally defined with reference to the model climate estimated by the re-forecast data.

In this way we remove the systematic biases from the forecast

Model climate

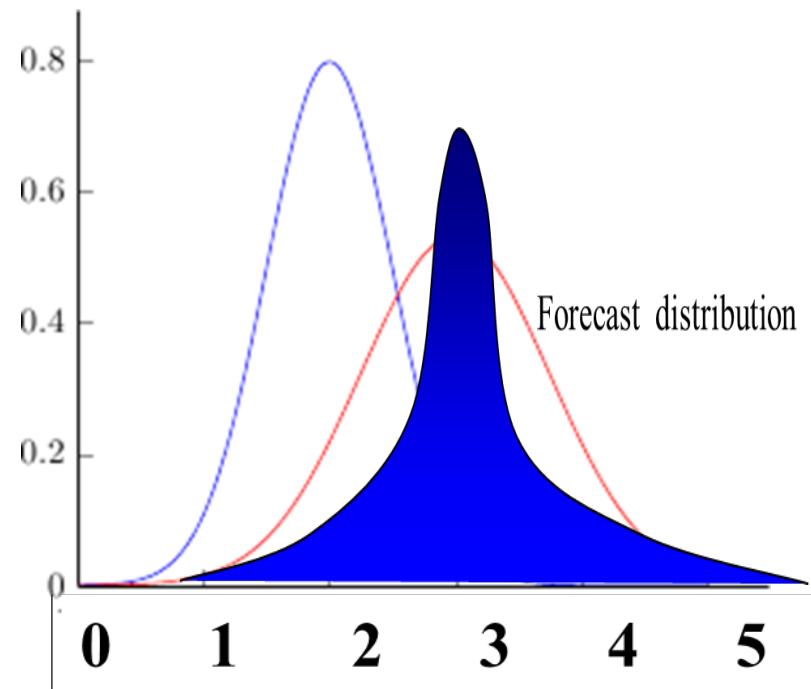
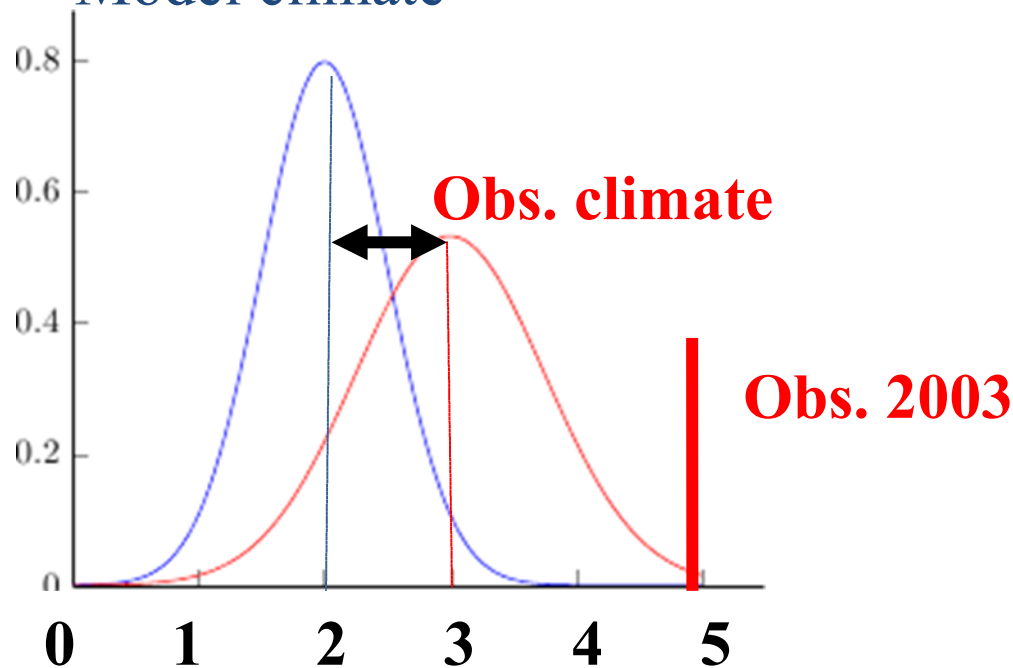

Implication for ENSO

teleconnections

2m temp anomalies in DJF

El Nino 1997/98

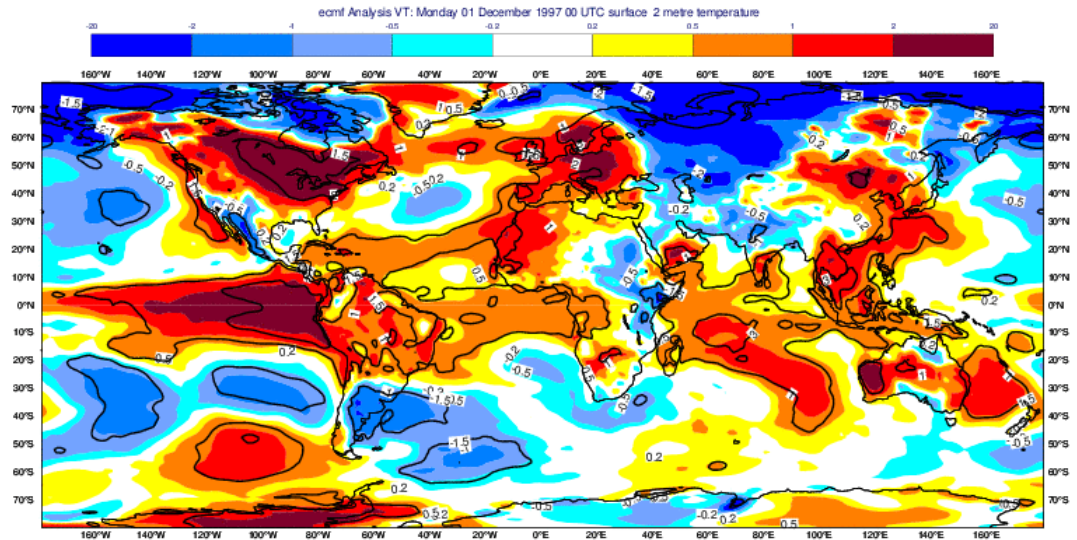

69

El Nino 1982/83

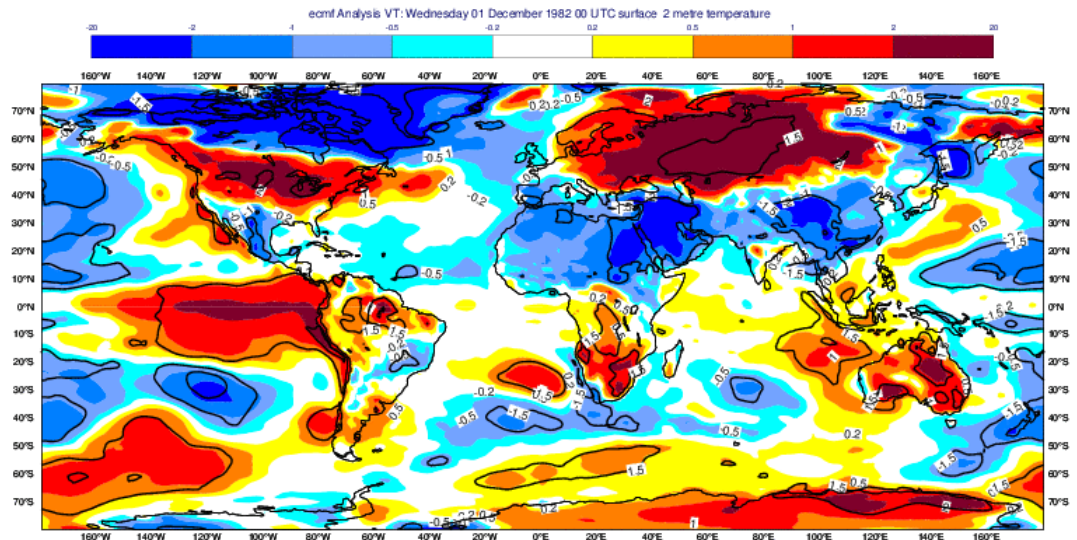

DJF 2014 : 2m temp anomalies

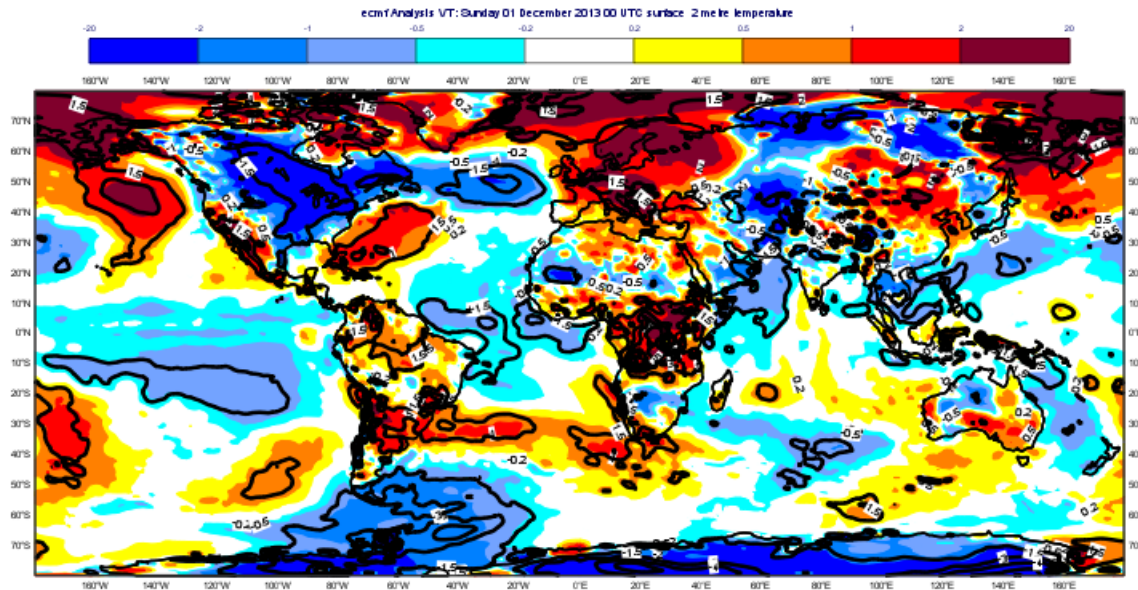

ECMWF Seasonal Forecast
Mean 2m temperature anomaly
Forecast start reference is 01/11/13
Ensemble size - 51, climate size - 450

System 4
DJF 2013/14
Shaded areas significant at 10% level
Solid contour at 1% level

EUROSIP multi-model seasonal forecast
Mean 2m temperature anomaly
Forecast start reference is 01/11/13
Variance-standardized mean

ECMWF/Met Office/Meteo-France/NCEP
DJF 2013/14

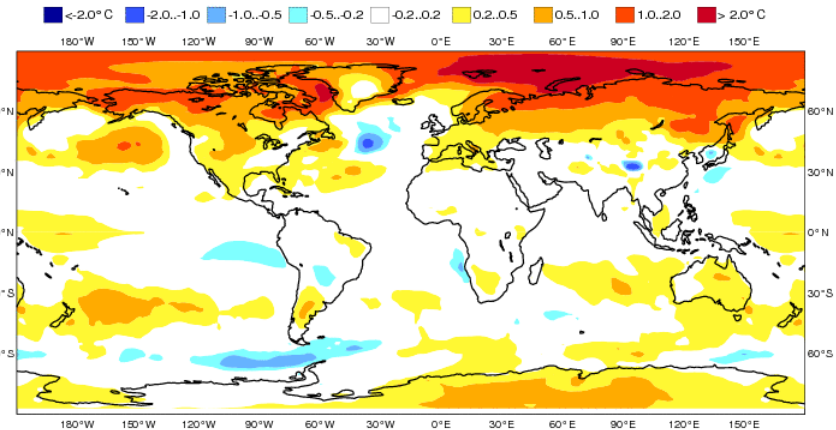
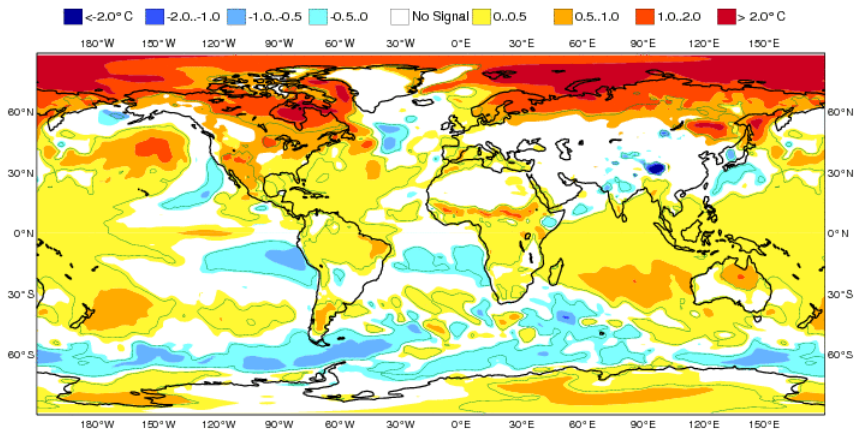

Predictability of seasonal mean anomalies: 2m temp anomalies averaged over Eastern Europe for

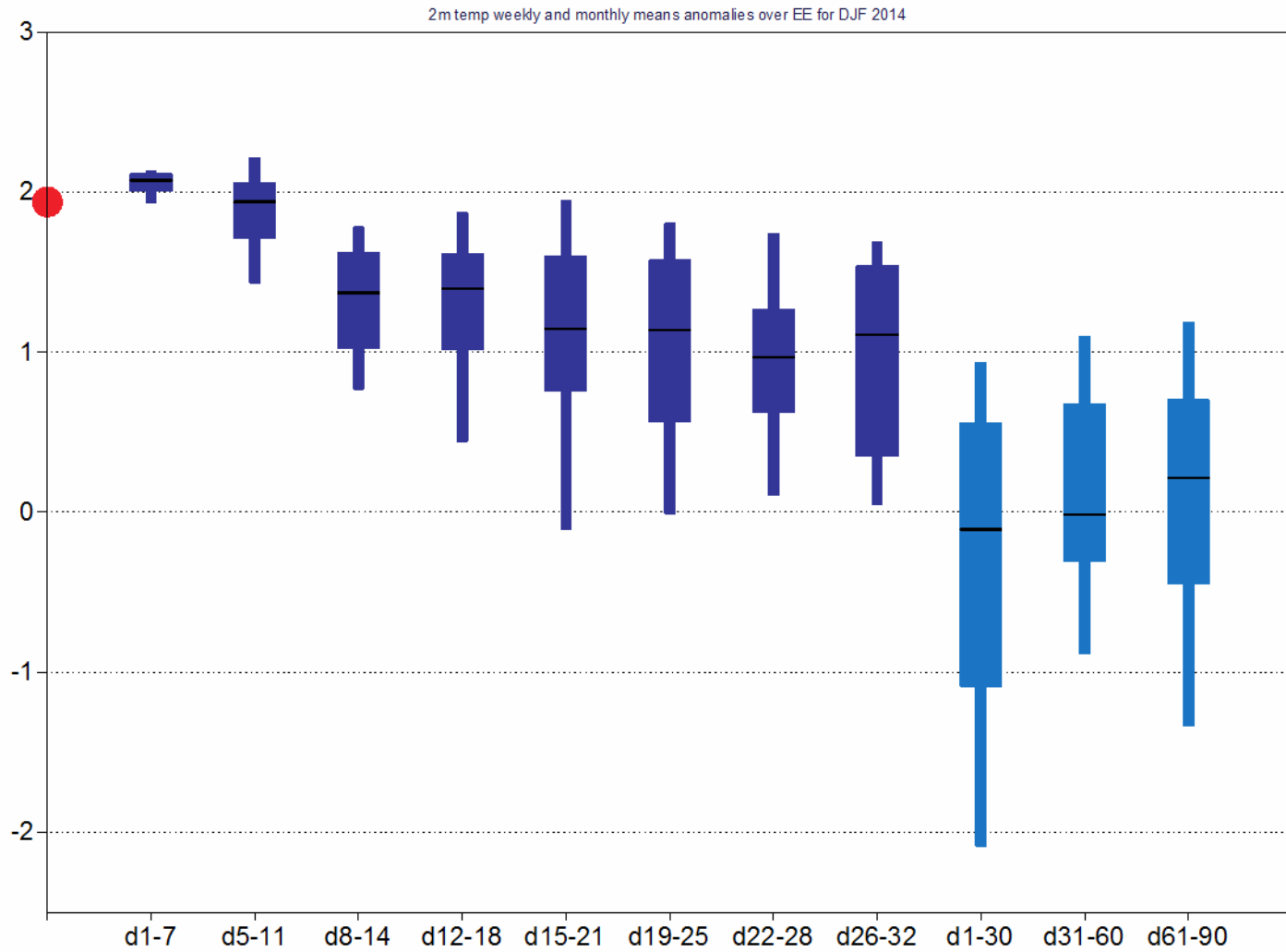

Predictability of seasonal mean anomalies:

Monthly system versus Seasonal system

2m temp. anomalies for DJF 2014 averaged over:

Eastern Europe

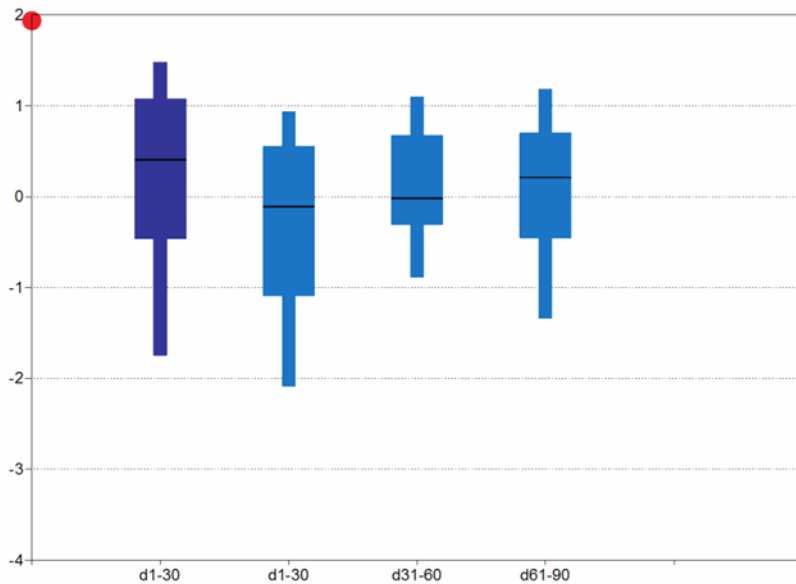

North America

