

# Cray XC30 Architecture Overview

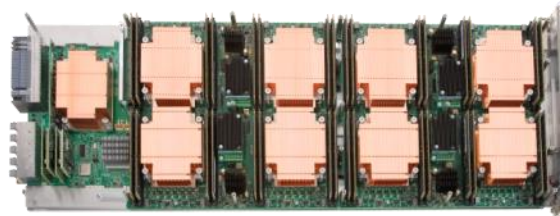



# Agenda

- **XC30 – The basics**
- **Packaging**
- **Board-level**
- **Processor**
- **Network**
- **Cooling**
- **Lustre Storage**



# Cray's recipe for a good supercomputer

- **Select best microprocessor**
  - Function of time
- **Surround it with a bandwidth-rich environment**
  - Interconnection network
  - Local memory
- **Scale the system**
  - Eliminate operating system interference (OS jitter)
  - Design in reliability and resiliency
  - Provide scalable system management
  - Provide scalable I/O
  - Provide scalable programming and performance tools
  - System service life





# Nodes: The building blocks

The Cray XC30 is a Massively Parallel Processor (MPP) supercomputer design. It is therefore built from many thousands of individual nodes.

There are two basic types of nodes in any Cray XC30:

- **Compute nodes**

- These only do user computation and are always referred to as “Compute nodes”

- **Service nodes**

- These provide all the additional services required for the system to function, and are given additional names depending on their individual task:
  - Login nodes – allow users to log in and perform interactive tasks
  - PBS Mom nodes – run and managing PBS batch scripts
  - Service Database node (SDB) – holds system configuration information
  - LNET Routers - connect to the external filesystem.

**There are usually many more compute than service nodes**

# Connecting nodes together: Aries

Obviously, to function as a single supercomputer, the individual nodes must have method to communicate with each other.

All nodes in the interconnected by the high speed, low latency Cray Aries Network.

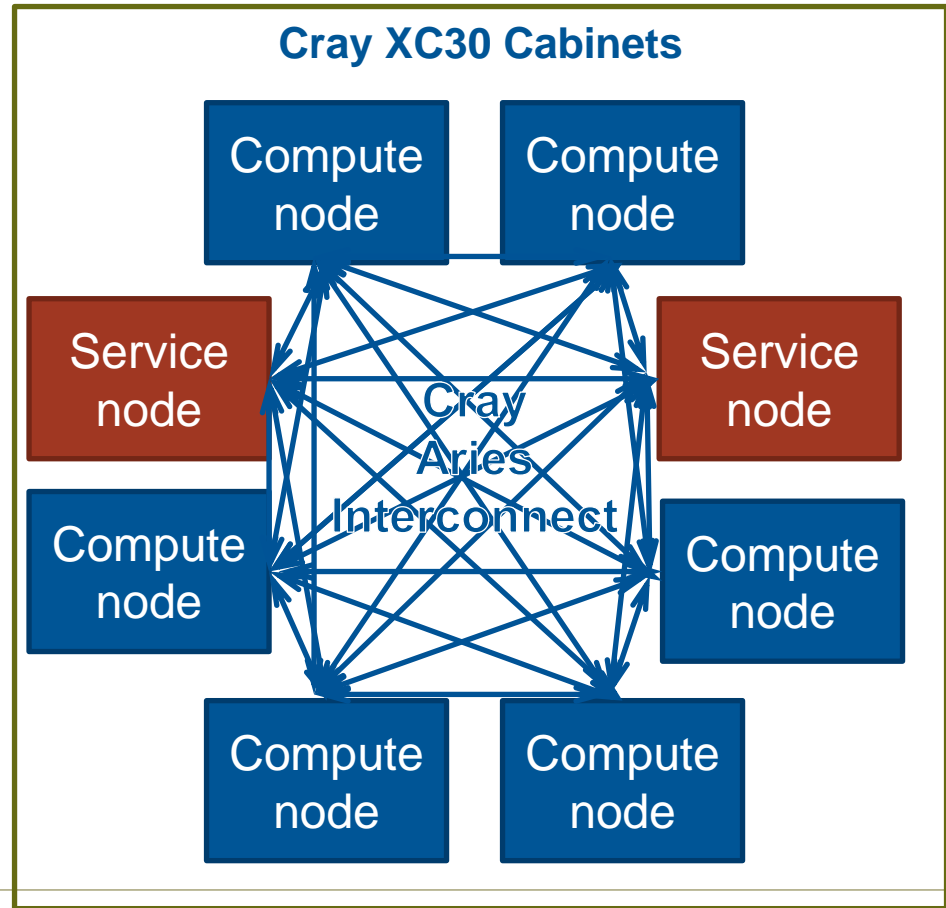



# Differences between nodes

## Service nodes

- This is the node you access when you first log in to the system.
- They run a full version of the CLE operating system (all libraries and tools available)
- They are used for editing files, compiling code, submitting jobs to the batch queue and other interactive tasks.
- They are shared resources that may be used concurrently by multiple users.
- There may be many service nodes in any Cray XC30 and can be used for various system services (login nodes, IO routers, daemon servers).

## Compute nodes

- These are the nodes on which production jobs are executed
- They run Compute Node Linux, a version of the OS optimised for running batch workloads
- They can only be accessed by submitting jobs through a batch management system (e.g. PBS Pro, Moab, SLURM)
- They are exclusive resources that may only be used by a single user.
- There are many more compute nodes in any Cray XC30 than login or service nodes.

# EXCEPTION: When is a compute node not a compute node?

- When it is a MAMU Node.
- Some customers call these pre-/post- processing or shared nodes
- These are compute nodes running the full Cray Linux Environment operating system.
- Used for sharing hardware between jobs/users running on less than a whole node.
  - i.e. serial jobs, small parallel jobs
- Essentially looks like a service node using compute node hardware.
- Accessible via PBS setup

# Interacting with the system

Users do not log directly into the system. Instead they run commands via an esLogin server. This server will relay commands and information via a service node referred to as a “Gateway node”

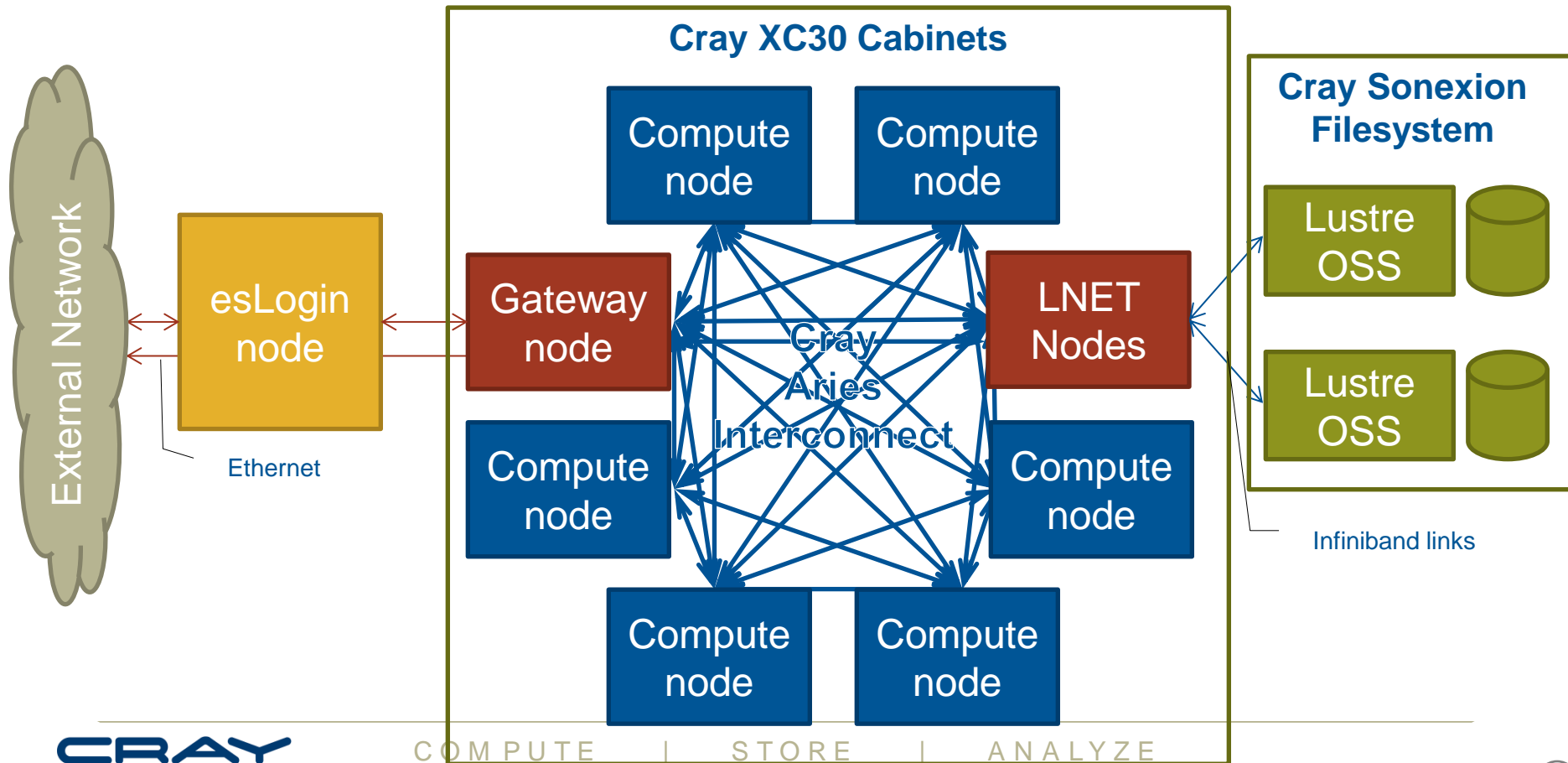





# Further Node Terms

- **Users cannot interact with these nodes directly**
- **SMW – System Management Workstation**
  - Used by system administrators to perform system tasks.
- **RSIP Nodes – Realm-Specific IP Nodes**
  - Service nodes that provide connectivity to external networks
- **Boot Node**
- **SDB Node – System Data Base**

# XC Architecture and Packaging

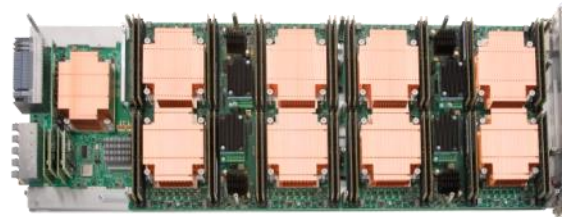

# Cray XC System Building Blocks

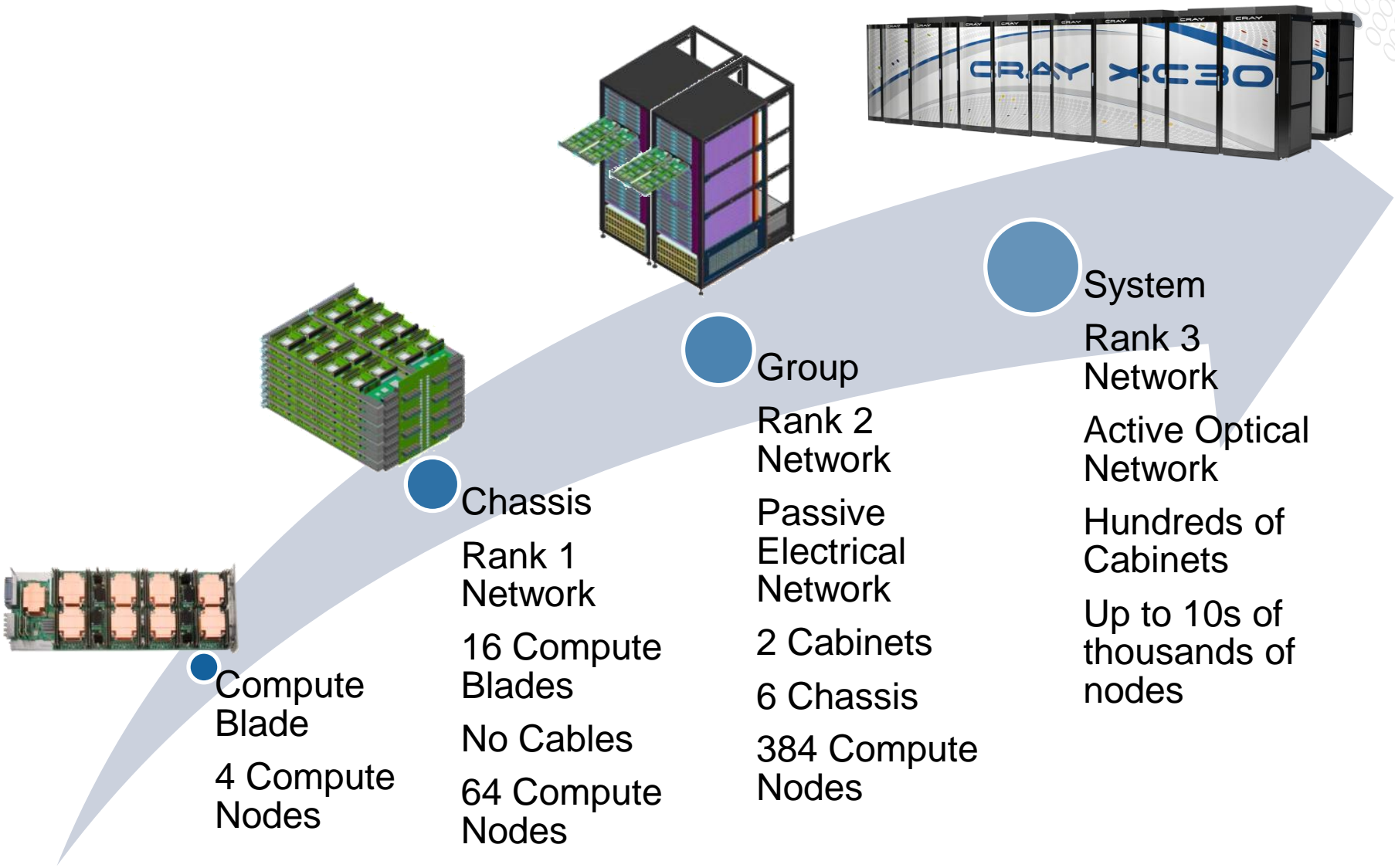

● Compute Blade  
4 Compute Nodes

● Chassis  
Rank 1 Network  
16 Compute Blades  
No Cables  
64 Compute Nodes

● Group  
Rank 2 Network  
Passive Electrical Network  
2 Cabinets  
6 Chassis  
384 Compute Nodes

● System  
Rank 3 Network  
Active Optical Network  
Hundreds of Cabinets  
Up to 10s of thousands of nodes

# Cray XC30 Intel® Xeon® Compute Node

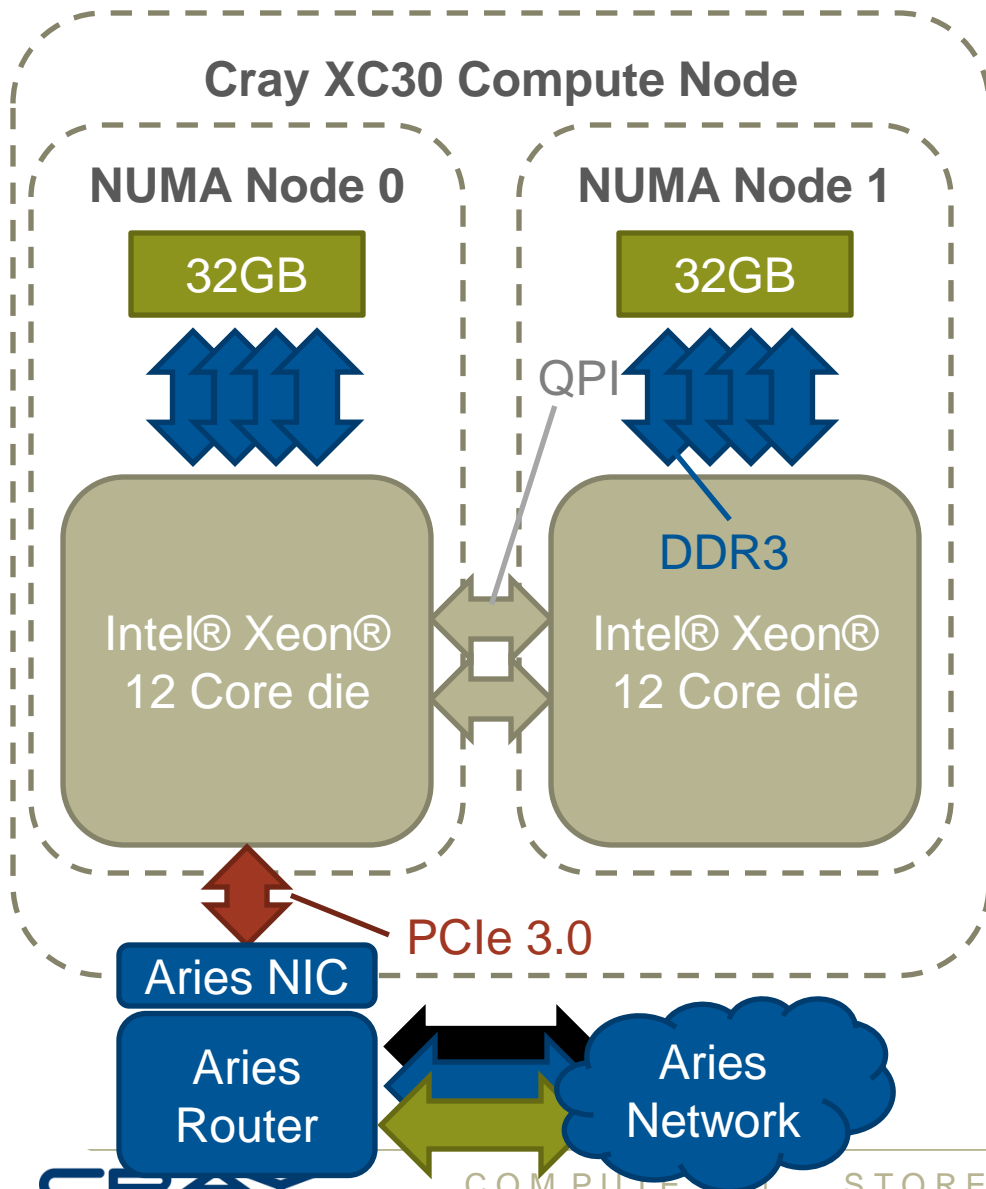

## The XC30 Compute node features:

- **2 x Intel® Xeon® Sockets/die**
  - 12 core Ivybridge
  - QPI interconnect
  - Forms 2 NUMA nodes
- **8 x 1833MHz DDR3**
  - 8 GB per Channel
  - 64 GB total
- **1 x Aries NIC**
  - Connects to shared Aries router and wider network
  - PCI-e 3.0

# Intel Xeon Ivybridge Core Structure

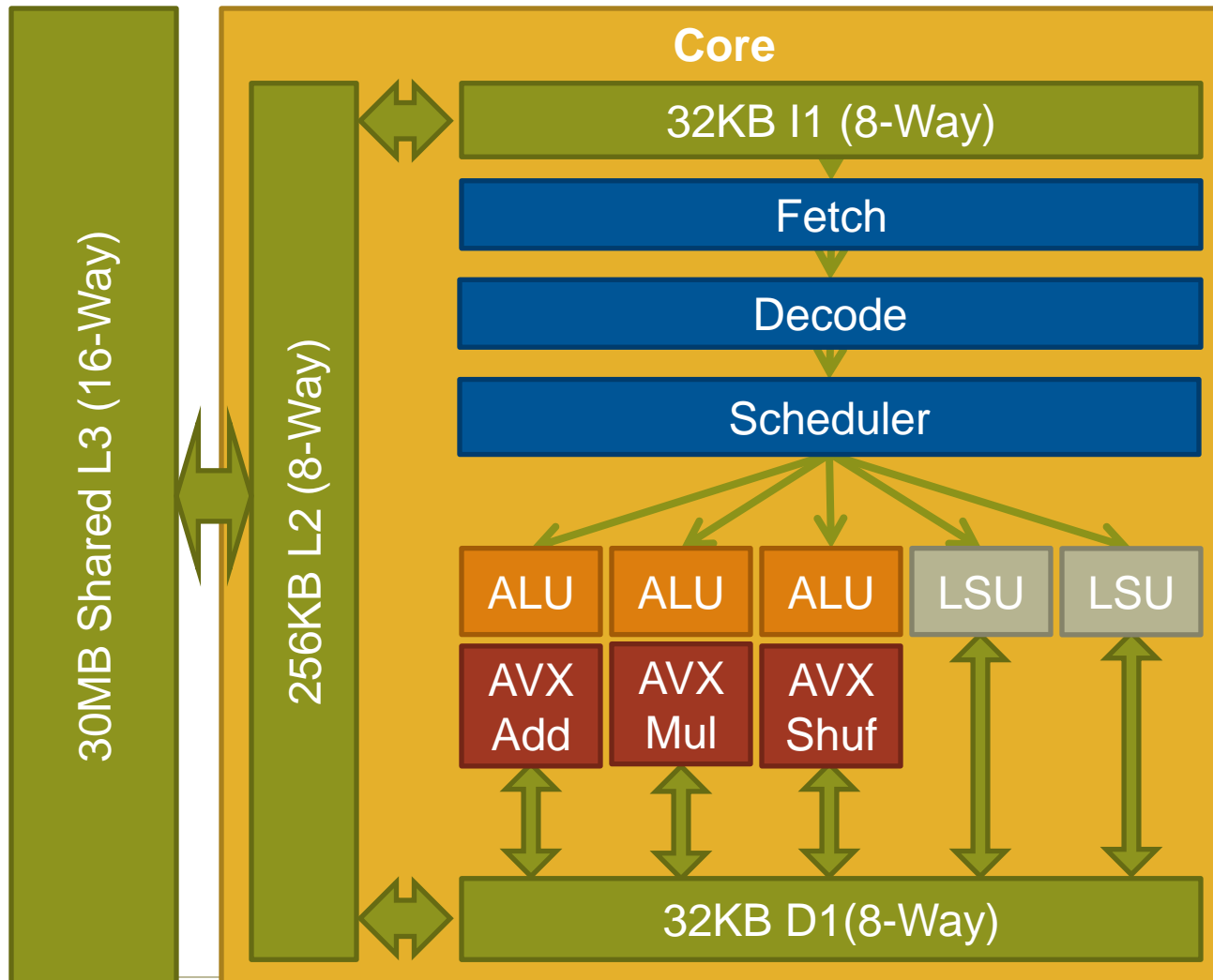

- Manufactured on the 22nm process
- 256 bit AVX instructions (4 double precision floating point/cycle)
  - 1 x Add
  - 1 x Multiply
  - 1 x Other
- 2 Hardware threads (Hyperthreads)
- Peak DP FP per node 8FLOPS/clock



# Cray XC Fully Populated Compute Blade

CRAY®

## SPECIFICATIONS

Module power:	2014 Watts
PDC max. power:	900 Watt
Air flow req.:	275 cfm (7.8 m <sup>3</sup> /min)
Size:	2.125 in x 12.95 in x 33.5 in
Weight:	<40 lbm (18 kg)

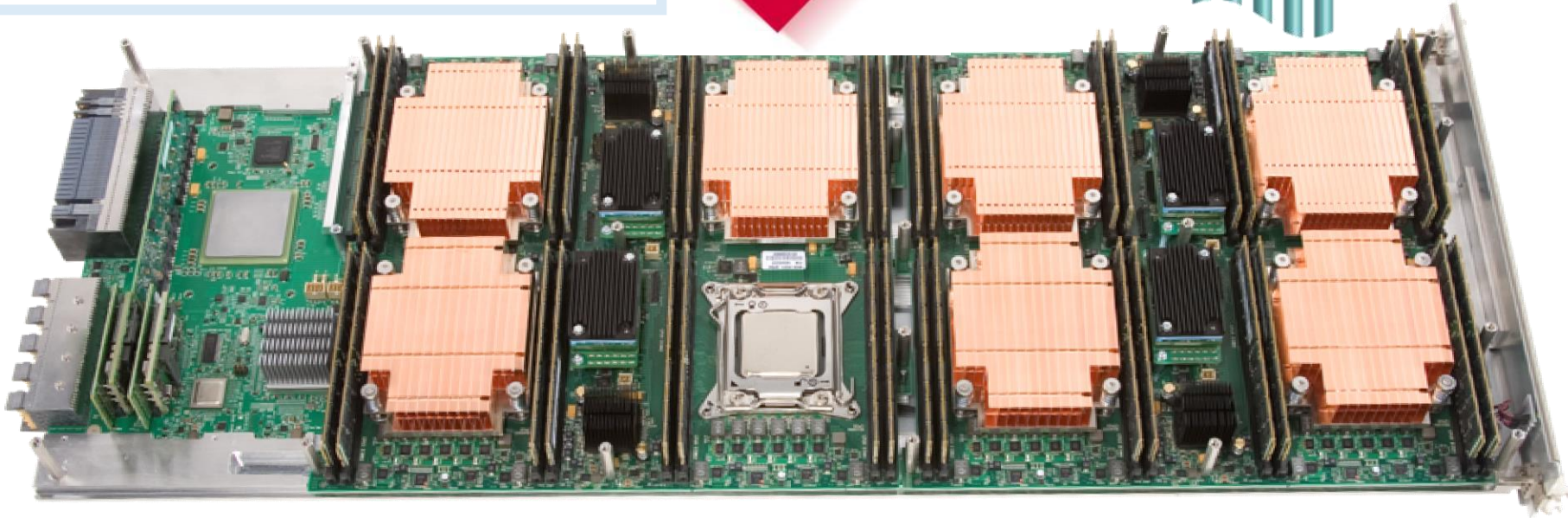
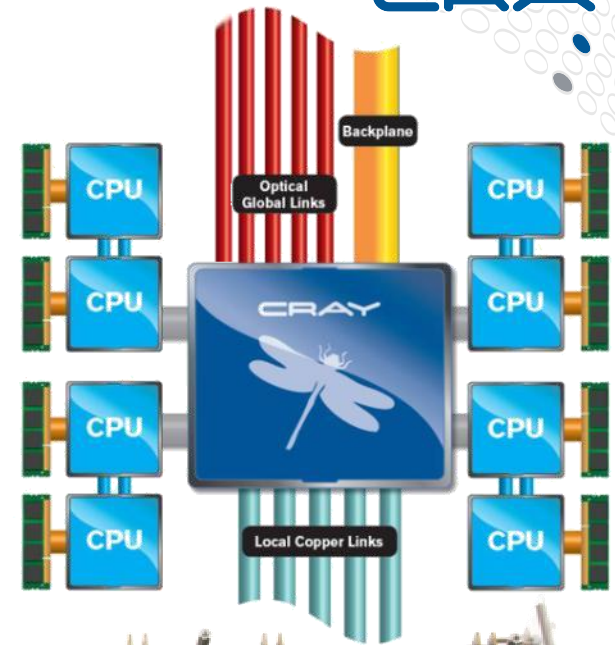
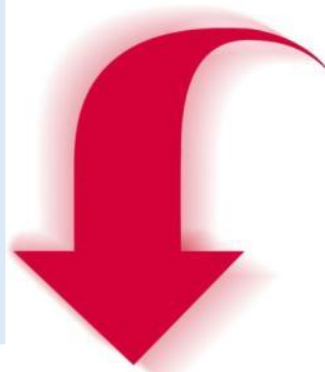

# PDC's (Processor Daughter Card ) are Upgradeable to New Technology

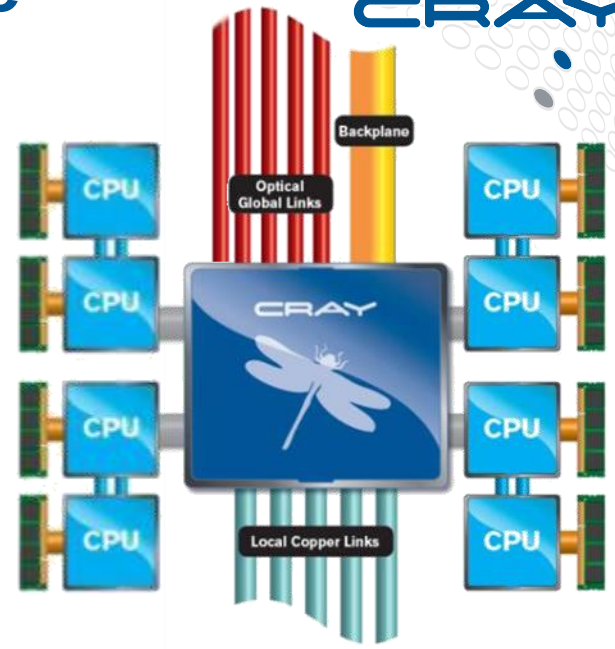



# Cray XC Quad Processor Daughter Card

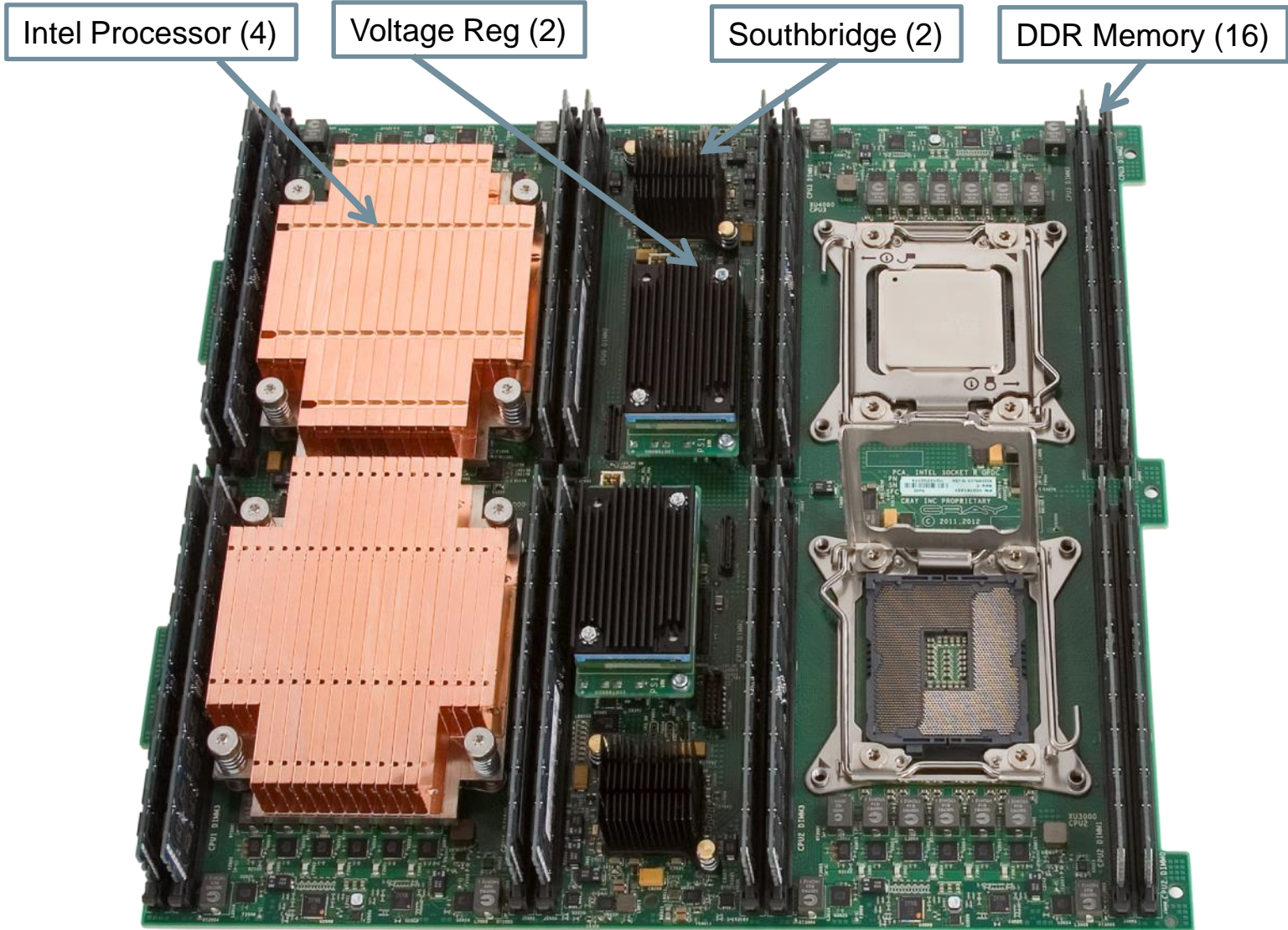

# Aries and the Dragonfly topology

# Cray XC Network

- The Cray XC system is built around the idea of optimizing interconnect bandwidth and associated cost at every level

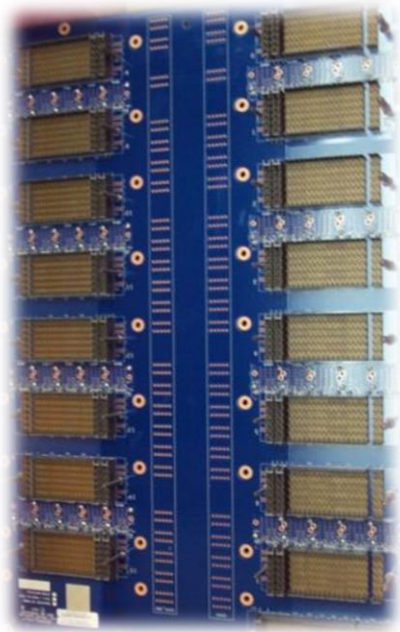

**Rank-1**  
PC Board: ¢¢¢



**Rank-2**  
Passive CU: \$



**Rank-3**  
Active Optics: \$\$\$

# Cray XC Packaging Review

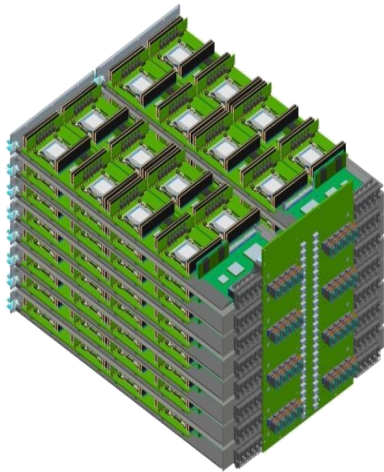

**Rank-1  
Chassis**



**Rank-2  
2 Cabinet Group**

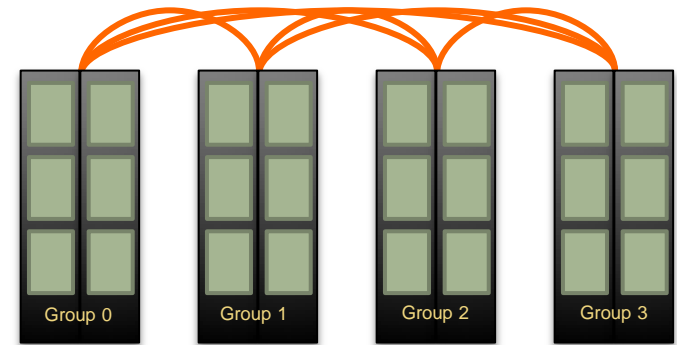

**Rank-3  
Between Groups**

- Aries is the Cray custom interconnect ASIC used in the Cray XC product family
  - 40nm process
  - Die size: 16.6 x 18.9mm
  - Gate count: 217M
  - 184 lanes of high speed SerDes
    - SerDes=Serializer/Deserializer (SerDes pronounced sir-deez)
  - 30 optical network lanes
  - 90 electrical network lanes
  - 64 PCI Express lanes
- **4 NICs**
  - Each Aries connects 4 nodes to the interconnect (Gemini connects 2)

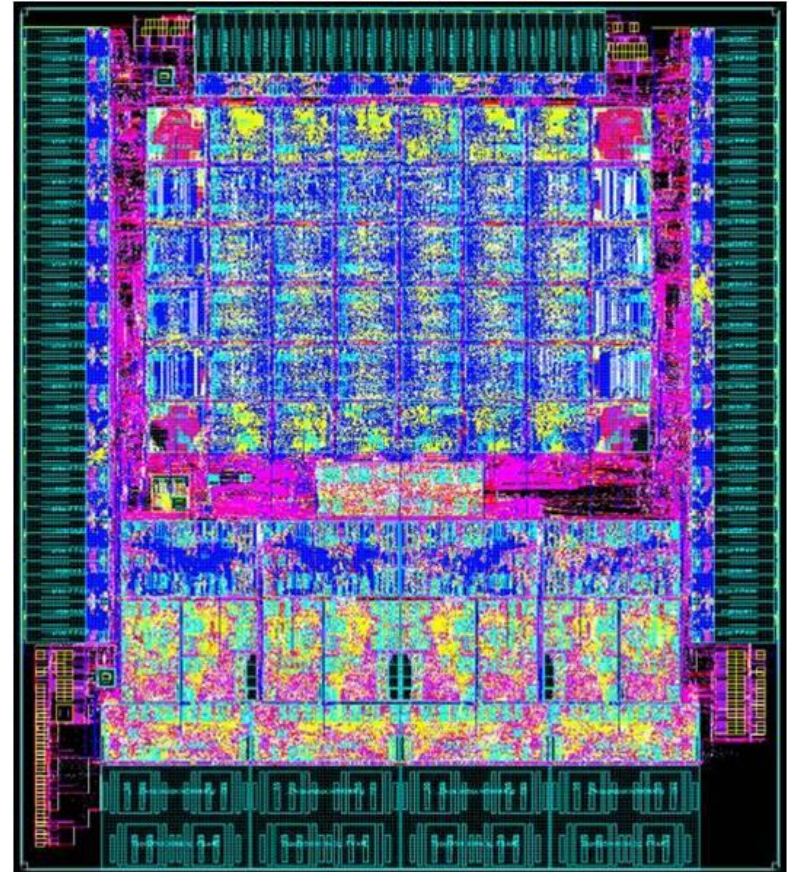

# Cray XC Rank1 Network

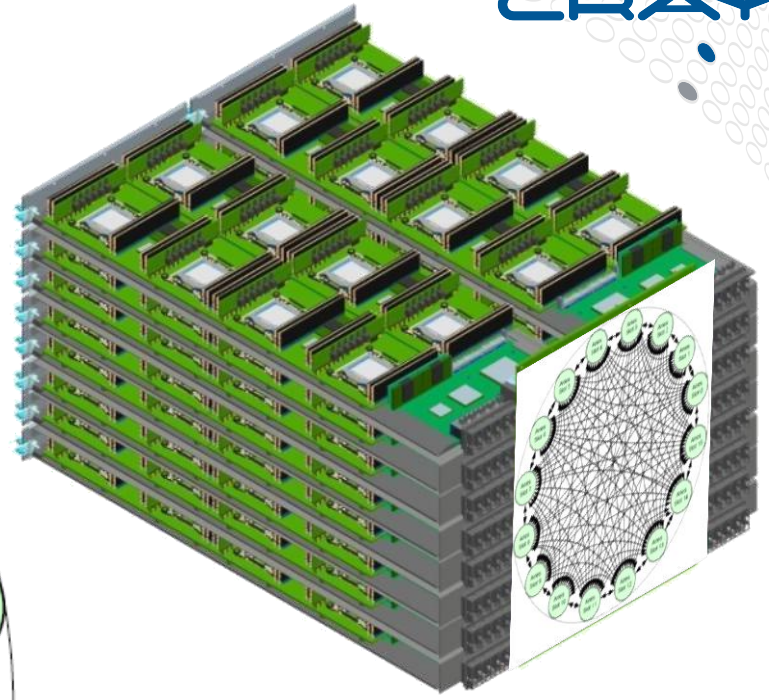
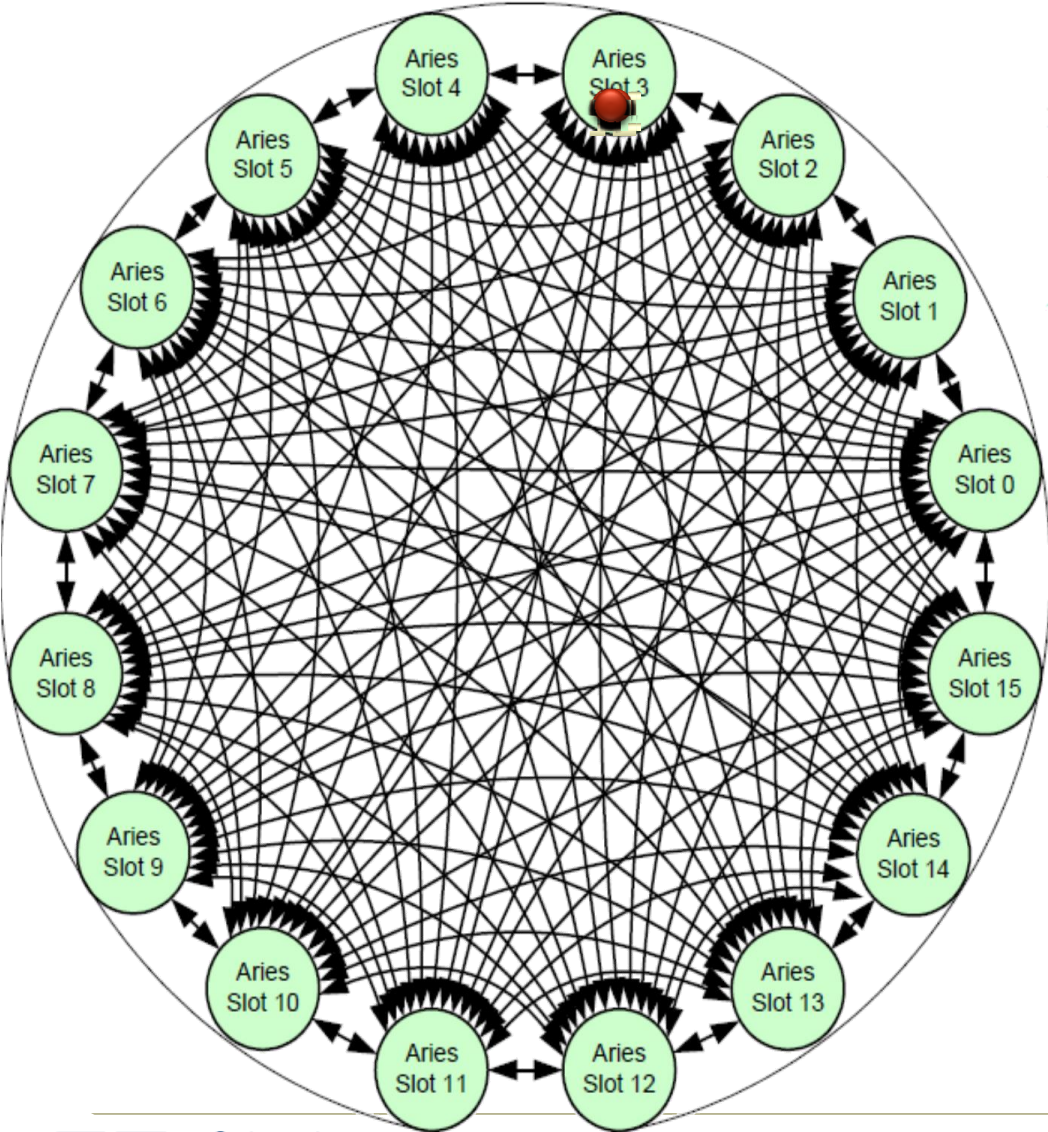
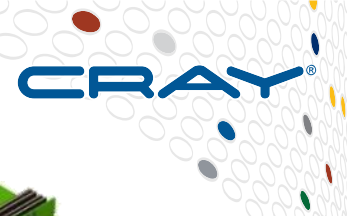

- Chassis with 16 compute blades
- 128 Sockets
- Inter-Aries communication over backplane
- Per-Packet adaptive Routing

# Cray XC Rank-2 Copper Network

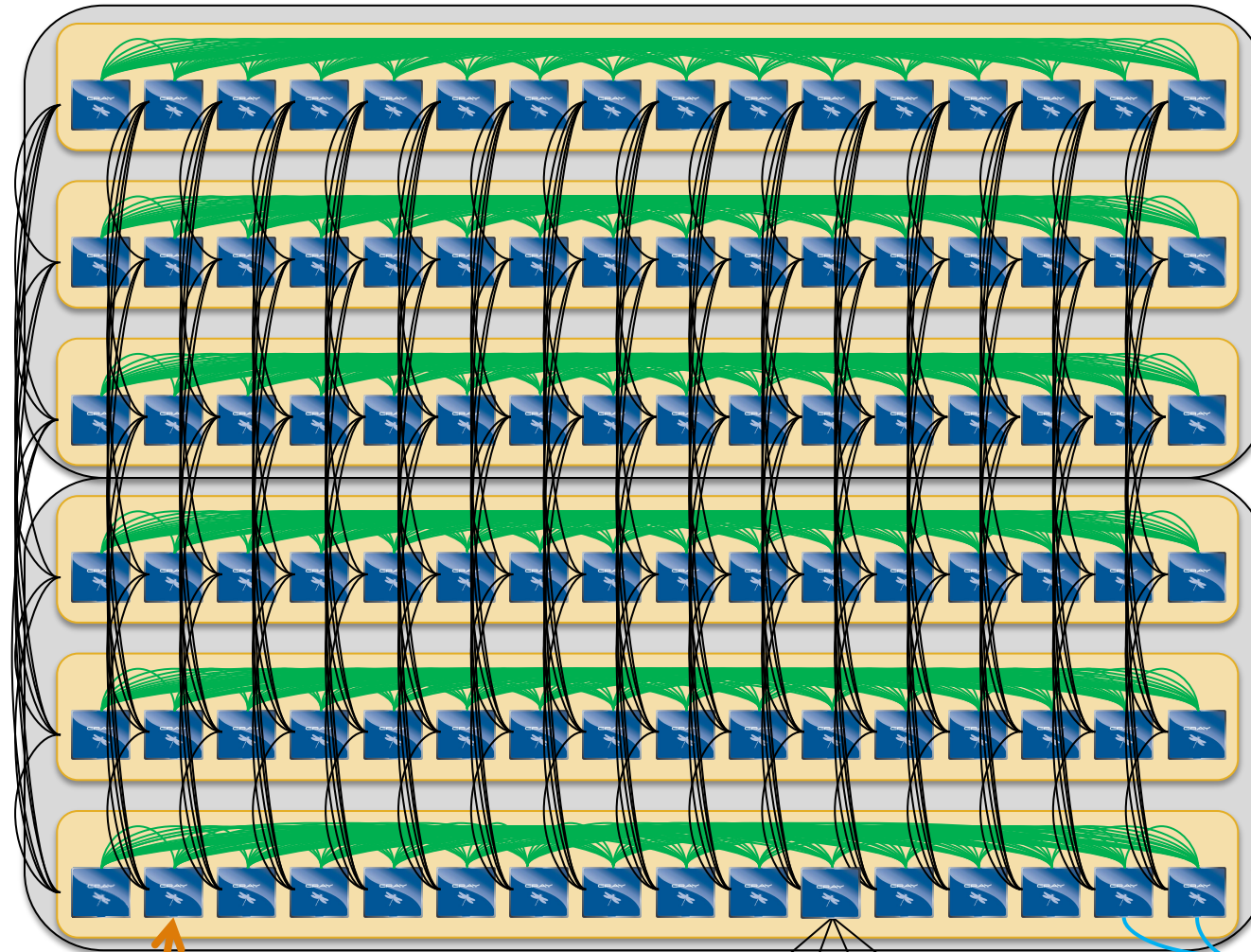

**2 Cabinet Group**  
768 Sockets



**6 backplanes connected with copper cables in a 2-cabinet group: "Black Network"**

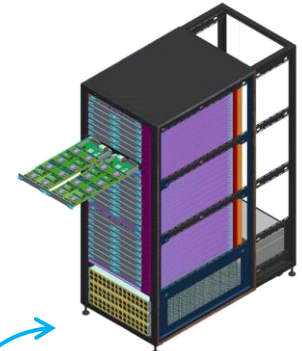

**Active optical cables interconnect groups "Blue Network"**

**16 Aries connected by backplane "Green Network"**

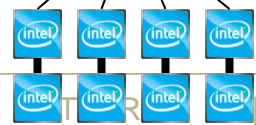
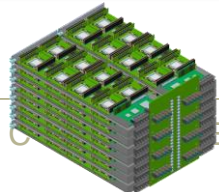

**4 nodes connect to a single Aries**

# Cray XC Routing

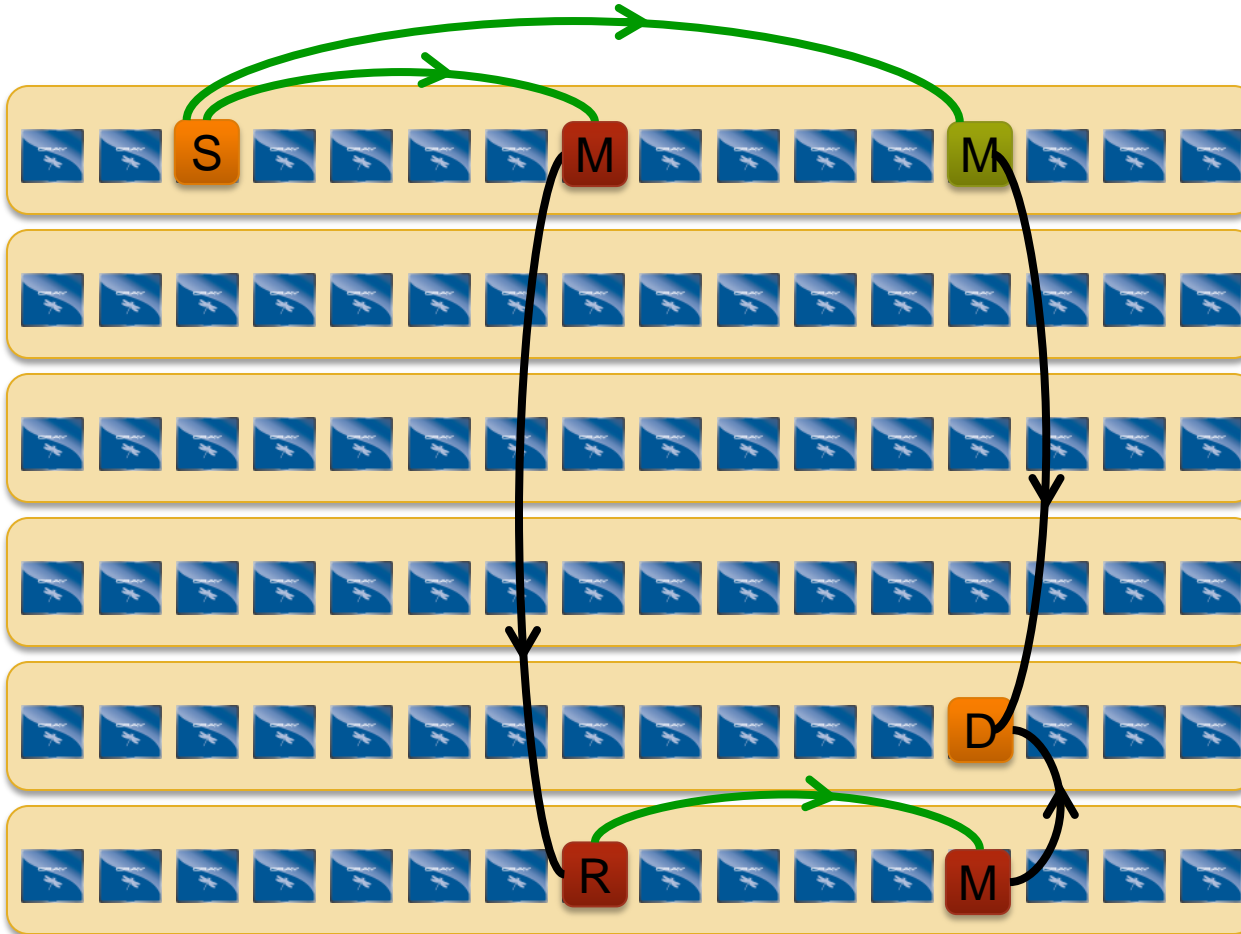

Minimal routes between any two nodes in a group are just two hops

Non-minimal route requires four hops.

*With adaptive routing we select between minimal and non-minimal paths based on load*

*The Cray XC Class-2 Group has sufficient bandwidth to support full injection rate for all 384 nodes with non-minimal routing*



# Aries Adaptive Routing Algorithm

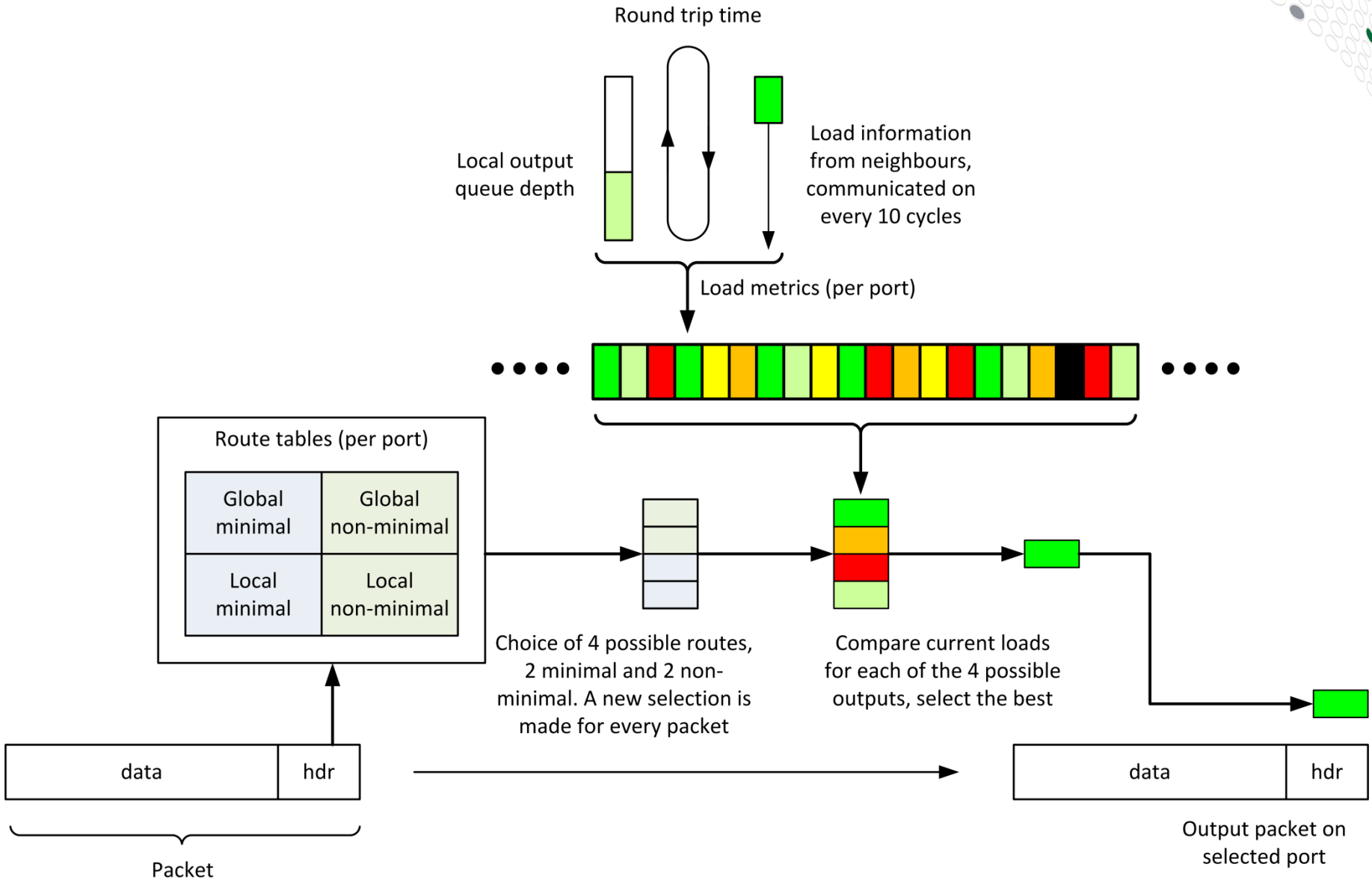

# Cray XC Network Overview – Rank-3 Network



- An all-to-all pattern is wired between the groups using optical cables (blue network)
- Up to 240 ports are available per 2-cabinet group
- The global bandwidth can be tuned by varying the number of optical cables in the group-to-group connections

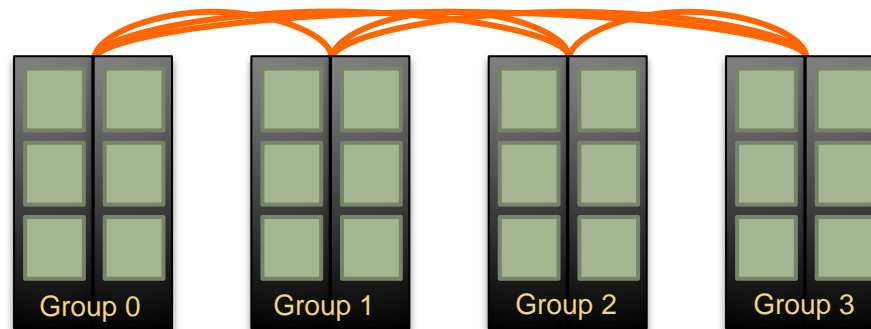

*Example: A 4-group system is interconnected with 6 optical “bundles”. The “bundles” can be configured between 20 and 80 cables wide*

# Adaptive Routing over the Blue Network



- An all-to-all pattern is wired between the groups

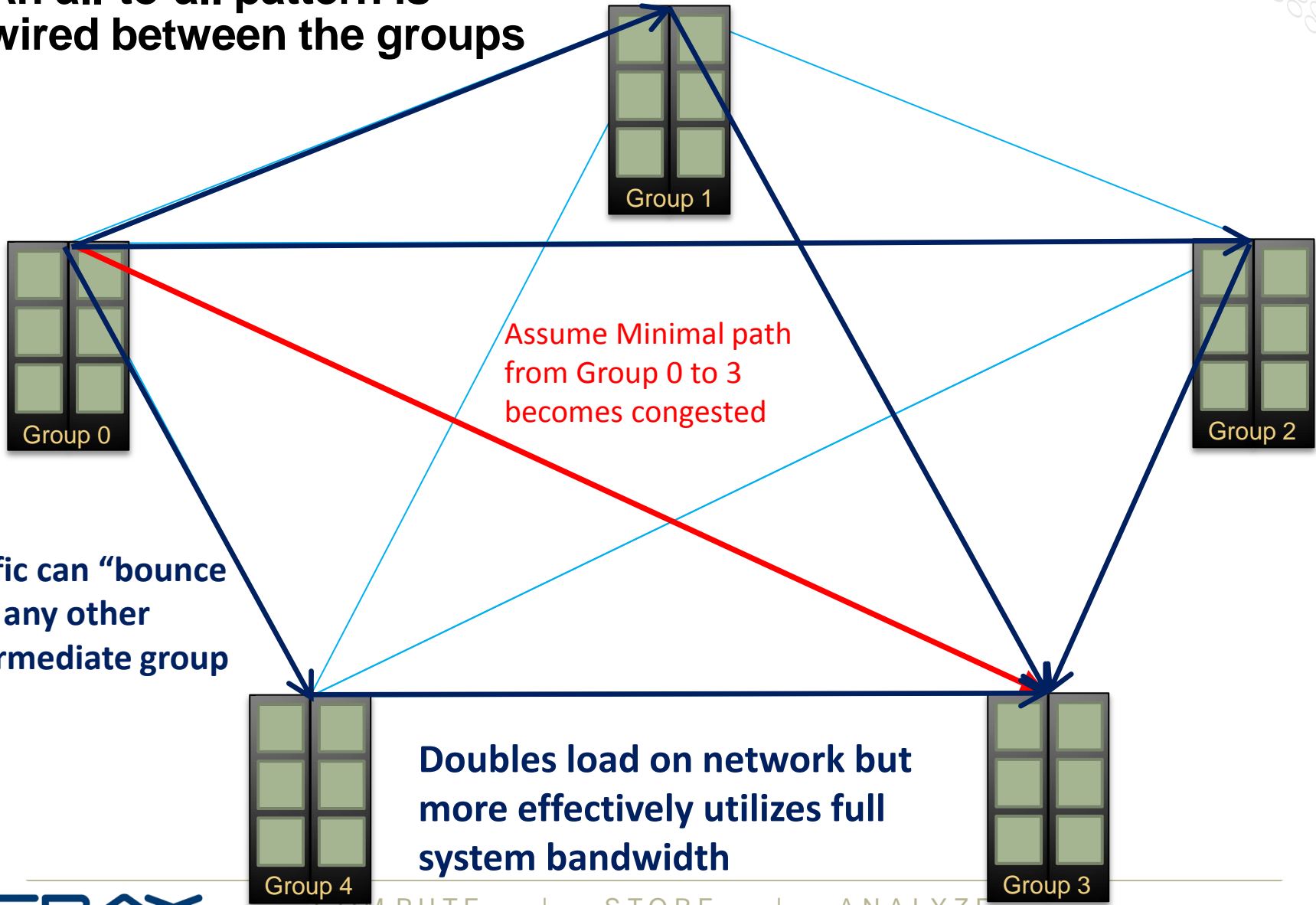

# Optical network saturation using the OSU MPI BM

This runs were done on Hornet (HLRS) with the 25% opt. cables config



- Saturating the optical network using communications between more and more nodes within 2 groups:

- 2x300 nodes:  
875 GB/s

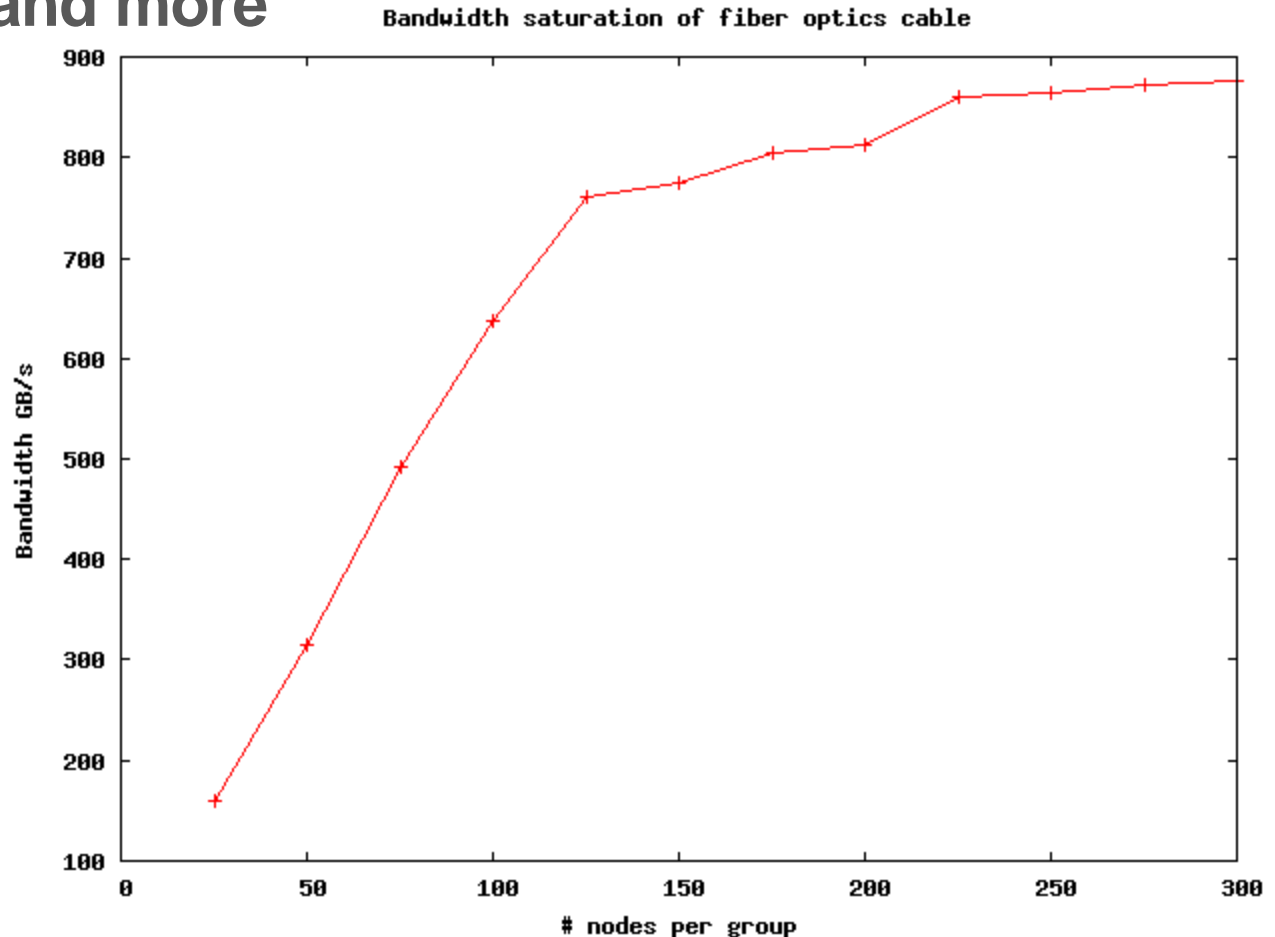

# Dragonfly is placement insensitive

- Example: Sandia miniApp, miniGhost
- Running on 2256 node (12 Cabinets) CSCS system (1/4 global bandwidth)
  - Runtime in seconds for 100 cycles

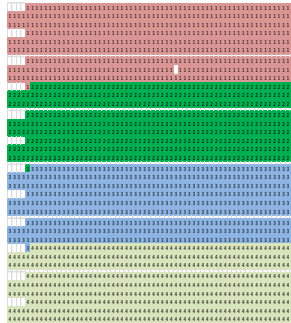

Contiguous Blocks of 512 nodes			
69.0	68.8	68.9	68.9

Perfect Placement

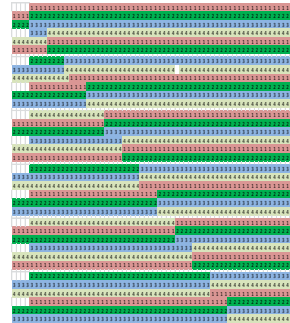

Random blocks of 64 nodes			
69.4	69.4	69.4	69.5

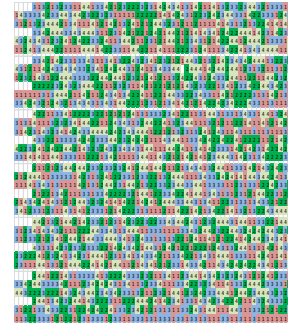

Random layout of nodes			
70.9	71.0	70.6	70.5

Worst-Case Placement

← →  
 < 3% variance from best-case to worst-case placement

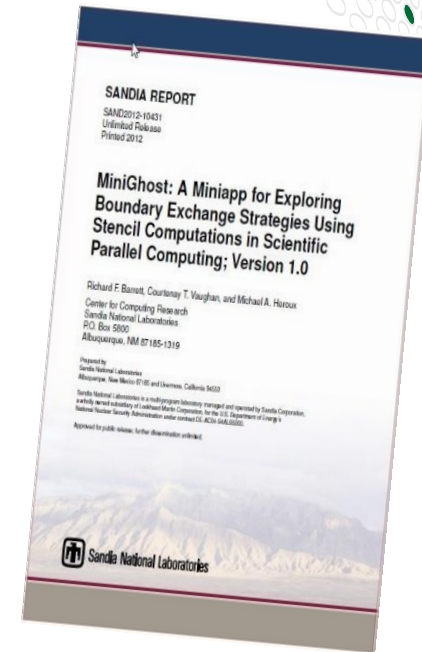

# Does Aries handle MPI Traffic with I/O Traffic ?



**I/O Messages**

**MPI Messages**

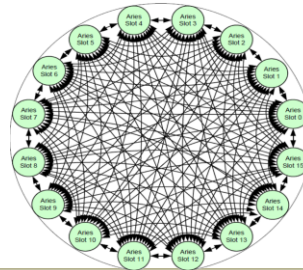

# Mix of application and streaming I/O traffic

- Analysis of the impact of big I/O traffic on performance of other codes
- Compared two runs
  1. Four miniGhost jobs spread out across the whole machine VS.
  2. Three miniGhost plus one performing big many-to-few I/O

Runtime for 4 simultaneous jobs, 3 miniGhost + checkpoint I/O

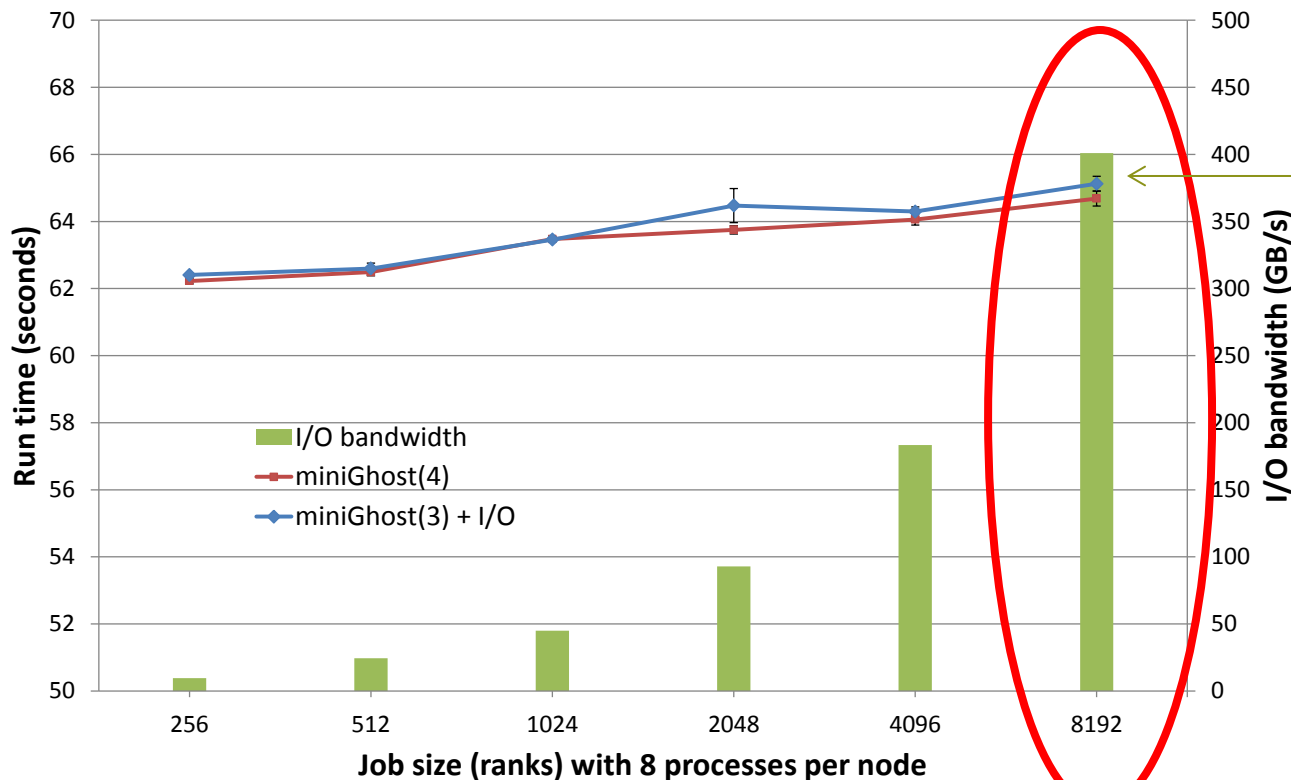

I/O Job sustaining 400GB/sec (95% clients to 5% servers)

Impact to compute jobs is tiny (64.5 sec to 65 sec)

# Why is the Dragonfly topology a good idea?



- **Scalability**

- Topology scales to very large systems

- **Performance**

- More than just a case of clever wiring, this topology leverages state-of-the-art adaptive routing that Cray developed with Stanford University
- Smoothly mixes small and large messages
- *Cray invested in bringing it to market – IBM and Mellanox have not*

- **Simplicity**

- Implemented *without* external switches
- No HBAs or separate NICs and Routers

- **Cost**

- Dragonfly maximizes the use of backplanes and passive copper components
- Dragonfly minimizes the use of active optical components





# XC Cooling

# XC Cooling Overview

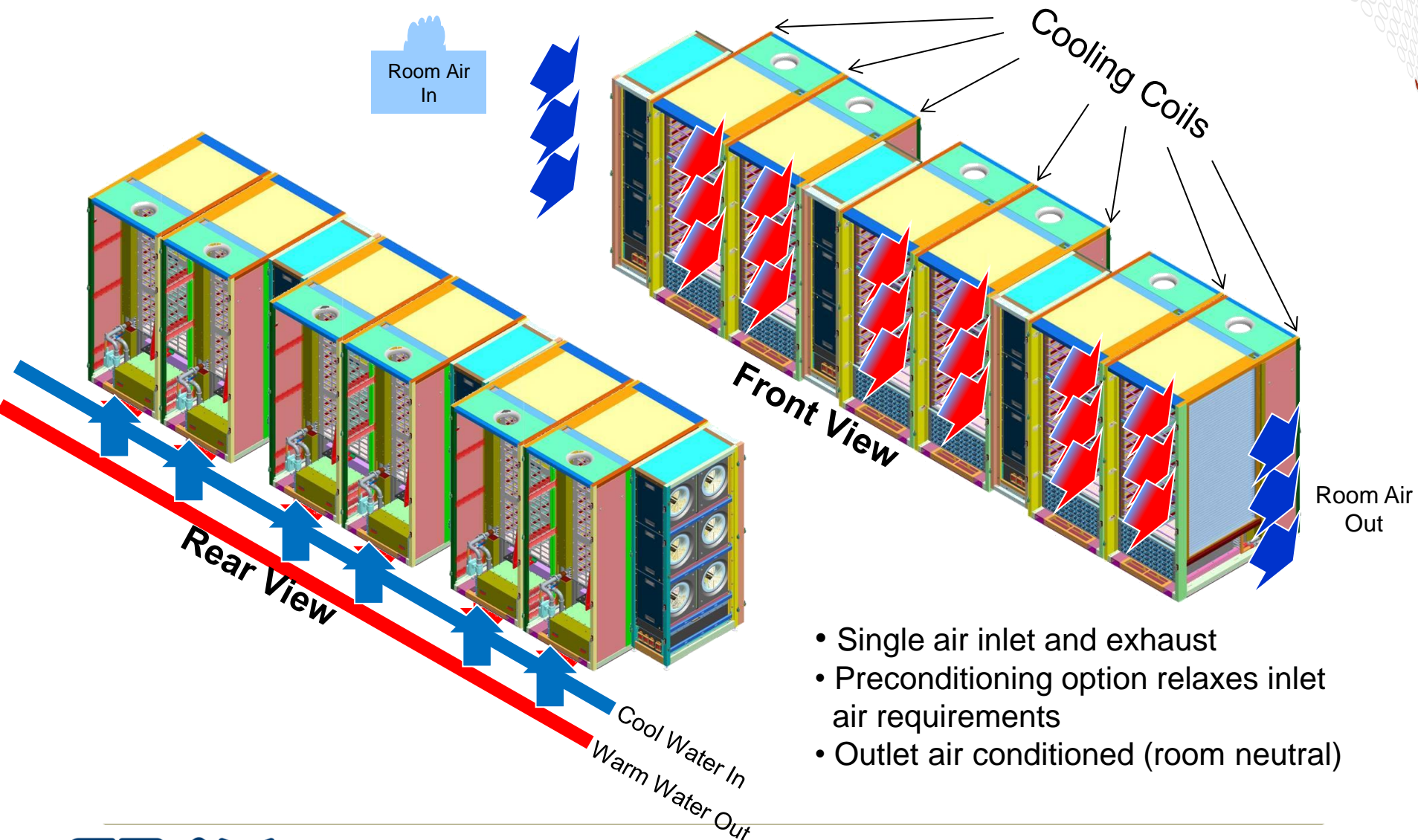

- Single air inlet and exhaust
- Preconditioning option relaxes inlet air requirements
- Outlet air conditioned (room neutral)

# Cray XC Transverse Cooling Advantages



## ● Performance

- Transverse cooling and graduated heat sink pitch ensure that all processors operate in the same thermal envelope
- “Turbo mode” works like it should in a parallel job

## ● Simplicity

- No airflow issues to manage or adjust
- System is 100% water-cooled
- No pumps, refrigerant, treated water, or plumbing on the blades

## ● Cost of Ownership

- Excellent PUE characteristics
- 25% better density than other ‘direct’ water cooled solution
- All cooling infrastructure is retained across multiple generations of computing technology

## ● Maintainability

- Blades can be warm-swapped without disturbing any plumbing
- Blowers can be hot-swapped if required and can provide N+1



# Storage

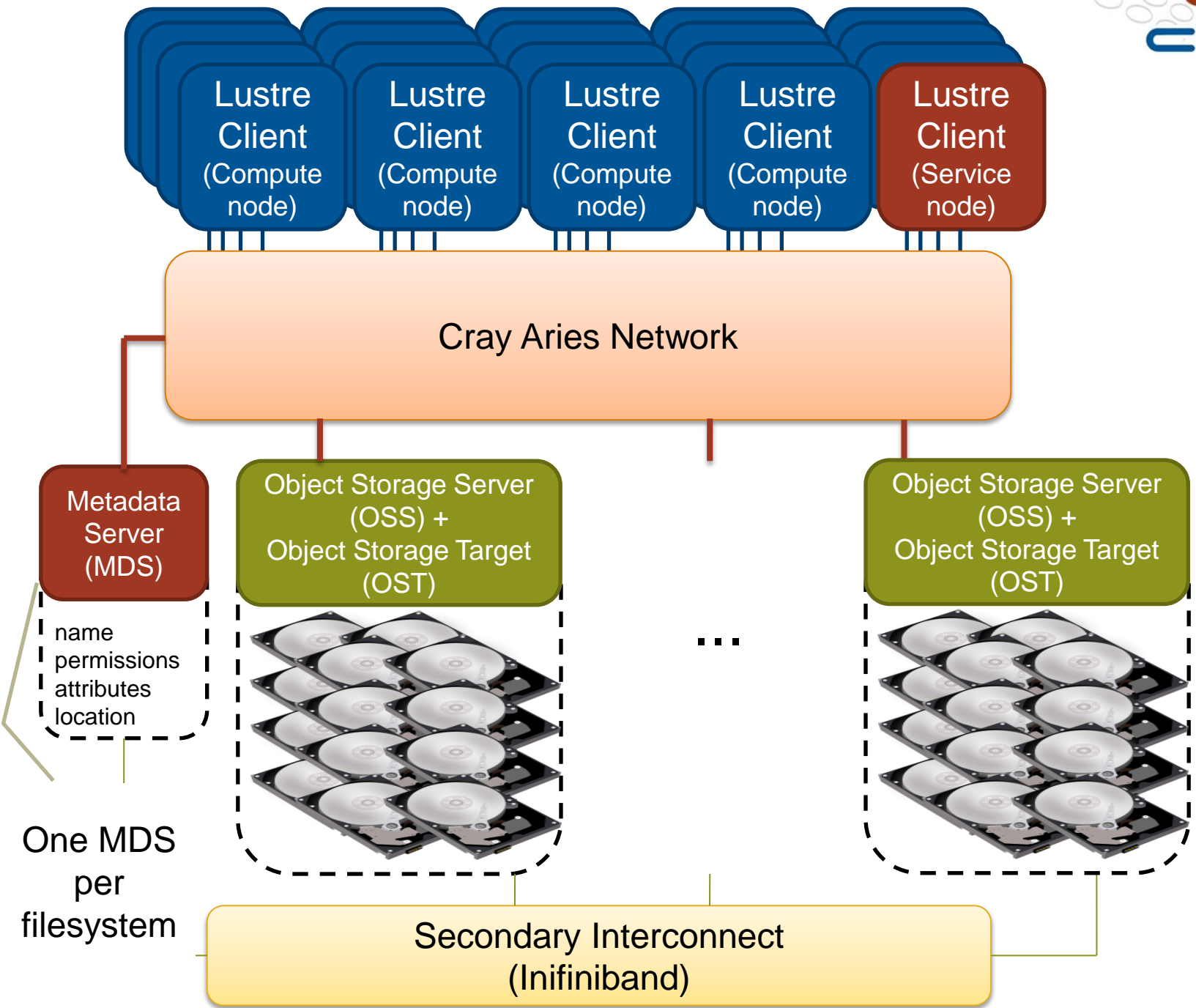

# Sonexion: Only Three Components

## 1 MMU: *Metadata Management Unit*



### Fully integrated metadata module

- Lustre Metadata software
- Metadata disk storage
- Dual redundant management servers
- Metadata storage target RAID

## 2 SSU: *Scalable Storage Unit*



### Fully integrated storage module

- Storage controller, Lustre server
- Disk controller, RAID engine
- High speed storage
- Provides both capacity and performance



### Fully prepared rack

- Prewired for InfiniBand, Ethernet and power
- Ready for instant expansion

3

# Filesystems on CCA

- **There are two Sonexion 1600 file systems mounted on CCA**
- **256 Lustre OSTs**
  - Each OST has 14.1 TB RAID-5
  - 3.6 PB Total
  - ~160 GB/s Read/Write bandwidth
- **144 Lustre OSTs**
  - Each OST has 14.1 TB RAID
  - 2.0 PB Total
  - ~90 GB/s Read/Write bandwidth

# Upgrade to CCA and CCB

- CCA and CCB will be upgraded to Cray XC40 Architecture





# Upgrade to CCA and CCB

- **Replace existing 2x19 Cabinet XC30s (CCA and CCB) by 20 Cabinet XC40s**
  - IVB-12 core > BDW-18 core
  - ~3373 nodes per XC40
- **Upgrade file system**
  - Sonnexion 1600 > Sonnexion 2000
  - Peak performance up to 1.7 TB/sec
  - 50% faster than Sonnexion 1600
  - 50% more usable capacity than Sonnexion 1600 (smaller footprint)

# Cray XC40 Intel® Xeon® Compute Node

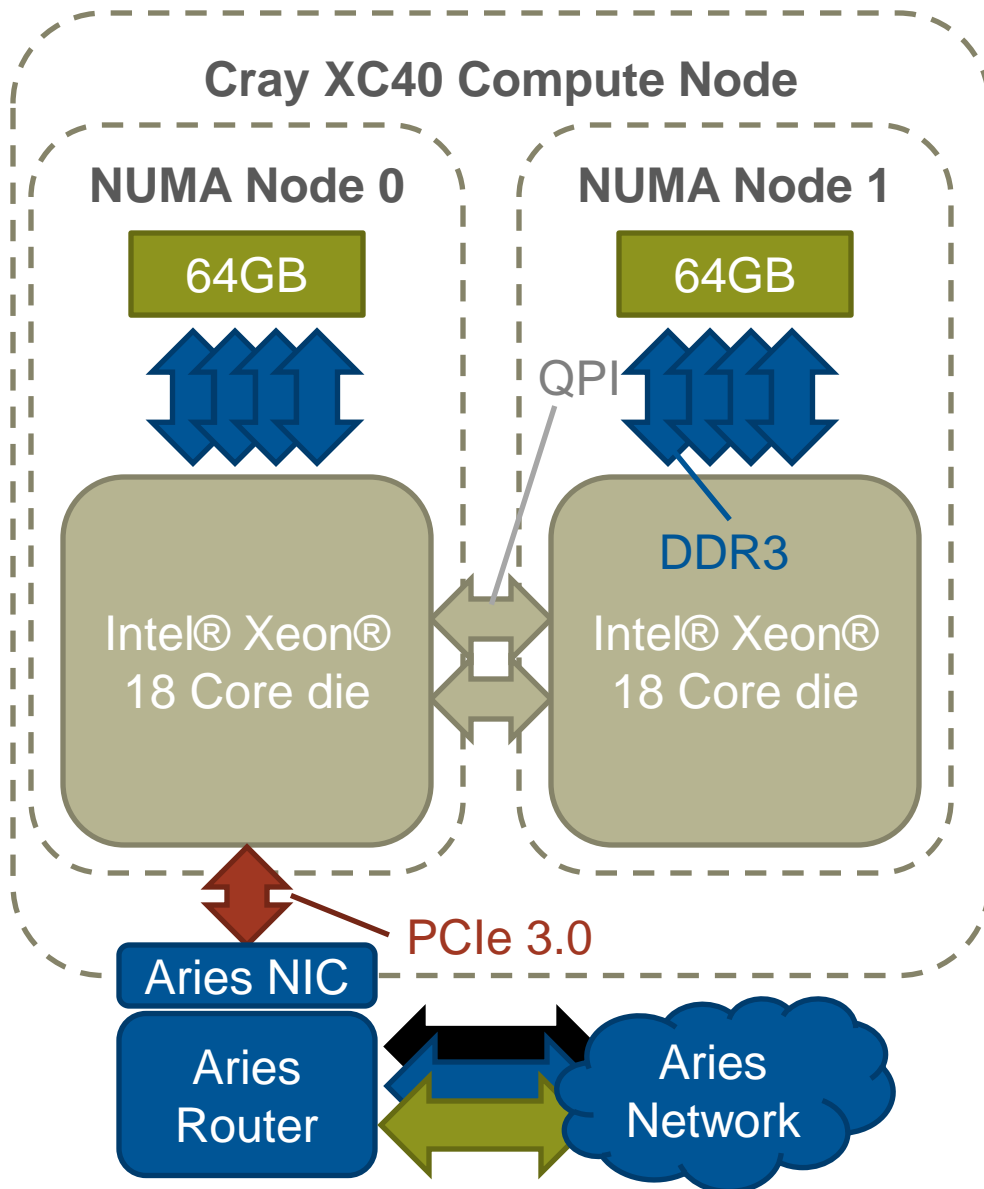

## The XC40 Compute node features:

- **2 x Intel® Xeon® Sockets/die**
  - 18 core Broadwell
  - QPI interconnect
  - Forms 2 NUMA nodes
- **8 x 2400MHz DDR4**
  - 16 GB per Channel
  - 128 GB total
- **1 x Aries NIC**
  - Connects to shared Aries router and wider network
  - PCI-e 3.0

# Broadwell vs Ivy Bridge

- **Intel Advanced Vector Extensions 2 (AVX2)**

- 256-bit integer vectors
- Fused Multiply-Add (FMA)
- Full-width element permutes
- Gather

- **2x cache bandwidth**

- 32-byte load/store for L1
- 2x L2-to-L1 bandwidth



	Broadwell
Instruction set	AVX2 & FMA
DP Flop / cycle	16
L1 Data cache	32kB 8-way
Load BW	64 B/cycle
Store BW	32 B/cycle
L2 Unified cache	256 kB 8-way
BW to L1	64 B/cycle



# Summary

- **XC30 – the basics**
- **Packaging**
- **Board-level**
- **Processor**
- **Network**
- **Cooling**
- **Lustre Storage**
- **Upgrade to XC40**